

GPX 5000 | 4800



IManual yemilayezelo



QALA MASINYA

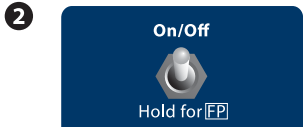

- 1 Faka amaswitch econtrol panel yangaphambili kumapozishini alandelayo.
- 2 Fithizela iOn/off switch ku control panel esemuva bese uyekela (ikhasi 26).
- 3 Sukumisa icoil bese ufithizela ibhathani le Auto Time (ikhasi 32) ukuze wehlise impambaniso yogetsi. Ukutshuna kungathatha citshe imizuzwana engamatshumi ayisithupha (60 seconds). Unganyikinyeza ikhoyili kumbe udulise loba yini enziwe ngensimbi duze layo kuze kuzwakali ukubhipha kathathu (3 beeps).
- 4

- 5 Tshuna iThreshold control (ikhasi 33) ngokutshilela phambili kuze kube lomsindo ozwakala kuhle kumaheadphone.

Uphakamisa uphinde wehlise ikhoyili, phakathi kwe25mm le 100mm (1" le 4") khatshana lomhlabathi ntshintsha iGround Balance switch uyifake ku Tracking (ikhasi 40).

- 6 Ukuntshintshantshintsha kweThreshold kuzaphela ngemizuzwana emithathu kusiya kwemihlanu (3 – 5 seconds).

Ntshintsha iThreshold (ikhasi 33) ibe phansi kodwa izwakale. Kufanele izwakale kuhle, intshintsha nje kancane.

Usukulunge ukuqala ukuhlola!

IMinelab ihlala ithakazelela imbono yakho nxa ulemibuzo kumbe imibono mayelana leGPX series yakho kumbe okunye okwenziwe yiMinelab zizwe ukhululekile ukuthintana lathi ngokusiqonda kumbe labo abathengisa izinto zeMinelab endaweni yakho nxa ufuna ukuzwa okunengi ngezinto zeMinelab kumbe amatip okuhlola umhlaba ungaya ku:

www.MINELAB.com

Amhlophe ngokuthenga eyakho iMinelab GPX^{Series} metal detector!

Ukudinga igolide ngumsebenzi othokozisayo njalo olemivuzo ethokozelwa ngabantu umhlaba wonke. Ngokwazi iGPX series detector yakho ungaba ngomunye wabanengi abathola igolide leinye inotho emangalisayo izikhathi ezinengi.

iGPX5000 le GPX4800 ngamagold detectors eMinelab aphambili. Yimitshina enika imiphumela emihle kakhulu ngokusebenzisa iMulti-Period Sensing (MPS). iDual Voltage Technology (DVT), iSmart Electronic Timing Alignment (SETA) kanye lama-analogue components aphezulu (high-tech) esebenza ledigital processing ephambili.

iGPX5000 le GPX4800 ziyalithola igolide kuyo yonke imihlobo yomhlabathi, ikakhulu leyo elenotho egejwayo enengi, ngobunono obedlula amadetectors akudala.

Lolugwalo lwenzelwe ukuncedisa oqalisayo loseyintshantshu yokudinga ukuze athole imiphumela emthokozisayo kuGPX5000 lakuGPX4800 yakhe.

iMinelab ikufisela impumelelo ekudingeni kwakho igolide lezinye inotho!



Bala ugwalo lwakho

Ingcazelo ezwisisekayo mayelana lokusetshenziswa kweGPX5000 loba iGPX4800 ikhona phakhathi kwalamakhasi. Ngokubala kuhle lolugwalo uzazwisisa ngcono ukuthi iMinelab metal detector yakho isetshenziswa njani.

GPX 5000 Range	Normal, Inverted
GPX 4800 Range	Factory Set to Normal
Factory Preset	Normal

Ekuqaliseni kwawo wonke amakhasi achaza iGPX series setting ongayintshintsha, i"Range" le "Factory Preset" yaleyo setting iyabe iqanjwe. Amanye ama-setting awantshintsheki kusiya ngomhlobo womtshina wakho ngakho afakwe kufactory set. Kumzekeliso ophezulu, irange etholakala kuGPX5000 yiNormal le Inverted besekusithi iFactory Preset yona yiNormal. iGPX4800 yona ilesetting engantshintshekiyo ngakho ifakwe kuFactory set to Normal.

2 Okumunyethweyo

Qala Masinya

- 4 Ukwethula iGPX5000 le GPX4800
- 6 Isibalo sezingxenye zomtshina
- 8 Ukuhlanganisa izingxenyezomtshina
- 16 Ukuntshintsha iDetector ukuze udinge ngendlela ethokozisayo
- 18 Ukutshaja ibattery
- 20 AmaLED pattern ebattery
- 21 Ukunakekela ibattery lakho
- 22 Okuqakathekileyo ngokudinga (detecting)
- 23 Imisindo yedetector (detector sounds)
- 24 Icontrol panel yophambili
- 25 Icontrol panel yangemuva
- 26 Ukulayitha idetector
- 27 Ukuma kweLCD Menu
- 28 ISearch mode
- 31 Ukutshuna/ukwehlisa impambaniso yogetsi
- 32 Ukuzitshunela komtshina
- 33 IThreshold/ukuntshintsha ibanga lomsindo ozwakalayo
- 35 Umhlabathi/amaTiming/ukuthuthukiseala imihlobo yomhlabathi lamatarget
- 36 ICoil/iRx/ukuntshintsha itransmit (Tx) le receive (Rx) field
- 38 Izilinganiso zomhlabathi/imbadalo yokwambiwa komhlabathi
- 40 Indlela yokuntshintsha iGround Balance nxa ukuTracking
- 42 Indlela yokuntshintsha iGround Balance nxa ukuFixed
- 44 Ukubuyisela amaFactory Preset
- 46 AmaFactory Preset
- 48 Isilawulo sokukhetha amafuction/dlaphendla amafuction
- 49 Inkinobho ysetting/Ukutshuna kuhle
- 50 Isilawulo samasetting/ukuntshintsha amasettingisibane seLCD

IPanel Functions yophambili



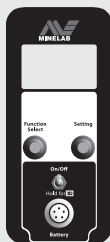

- 51 **Ukuhlola ibattery**/ukukhangela umlilo webattery
- 52 **Ukulawula umsindo**/ukuhlela ibanga eliphezulu kuyo yonke imisindo
- 54 **Umhlobo weGround Balance**
- 56 **Indlela yokuhlela iGround Balance kuSpecific**
- 57 **Okuqakathekileyo**/umhlabathi /amaTiming
- 59 **Ukutshuna ngezandla**/ukwehlisa impambaniso yogetsi
- 60 **Ukutshuna amaSearch mode**/usebenzisa iLCD
- 62 **IMotion**/ukuntshintsha isigubu sokuhambisa icoil phezu komhlaba
- 63 **IRx gain**/ukuntshintsha umsindo wama target signal
- 64 **Umhlobo we Audio**/ukuntshintsha umphatho loqhweba lwe Audio
- 65 **Umsindo ozwakalayo**/ukuntshintsha izinga lomsindo weThreshold
- 66 **IStabiliser**
- 67 **Ukuqansa komsindo wesignal**/ukwehlukana kwamazinga omsindo wetarget signal
- 68 **Ibanga lomsindo wetarget**
- 69 **Iresponse**/ukuntshintsha izinga lomsindo wetarget signal
- 70 **Ijubane lokucinga**/ukuhambelana lomumo wokuntshintsha komhlabathi
- 72 **Insimbi elahlayo**
- 74 **Insimbi elahlayo**/ukulahlwa kwe ferrous lamatarget
- 76 **Igama losiko**/ukuntshintsha igama lomumo wesiko lukudinga
- 77 **Ukukhomba**/Ukudinga indawo elilitshe
- 79 **Ukugebha ilitshe**
- 81 **Amacebo okuzingela**
- 83 **Amakhoyili ohlobo lweCommander**
- 85 **Ukukhetha ikhoyili eqondileyo**
- 87 **Nxa umtshina usuleninga**
- 88 **Amagama lengcazelo zawo**
- 91 **Ukunakekela umtshina wakho**
- 92 **Intando yabasebenzisayo**
- 94 **Amatechnical specifications**
- 95 **Iwarranty**
- 96 **Iform lomsebenzi lokulungisa**

Ukwethula iGPX⁵⁰⁰⁰ le GPX⁴⁸⁰⁰



IGPX series isebenzisa iDual Voltage Technology (DVT) esike yasetshenziswa ngokulempumelelo yiMinelab. Lokhu kuyancedisa ukuthi kube le Ground Balance elungileyo okwenza kube lamathuba amahle okubamba lapho okulegolide (sensitivity) lamatarget akhatshana (depth) kuyo yonke imihlobo yomhlabathi.

IGPX5000 inika amaTiming option afika kwayisitshiyangalombili (8), iGPX4800 yona inika ayisithupha (6); yinye ngayinye isebenzisa leSETA technology entsha. iSmart Electronic Timing Alignment (SETA) yenza idetector ihambisane leTiming option yinye ngayinye. Lokhu kuthuthukiswa kokusebenza komtshina kwehlisa amathuba okuhlaselwa kwawo ngezinye izinto ezingaphambanisa ukusebenza kwawo kuphinde kwandise amandla okunganaki amadwala lemihlobo yomhlabathi emagnetic ngokuphezulu.

Isebenzisa uhlelo lwedynamic noise compendation, iSETA iyathuthukisa ukuma kwethreshold njalo yenza kuhlale kunjalo okwenza uvumeleke ukusebenzisa iGPX5000 le GPX4800 ngempumelelo enkulu kuzo zonke izimo.

IGPX5000 inika amaSearch mode alungisiweyo ayisithupha (6), kuthi iGPX4800 yona inika amathathu (3). Yombili imitshina ilungiselwe indlela zokusetsha (search) ezejwayekileyo.

Isearch mode yinye ngayinye ingalungiswa ngokuphendla amafunction amanenginengi edetector kuntshintse amasetting.

IGPX5000 le GPX4800 okulamafunction athuthukisiweyo lamatiming amatsha kuyenelisa ukuthola izijumba zegolide emihlobeni etshiyeneyo yemihlabathi kalula kulamadetector akudala.

Umhlobo weGround Balance (GB)

Umhlobo weGround Balance ulamasetting amathathu (3); Normal, Specific le GB Off. INormal yisetting ejwayele ukusetshenziswa emihlobeni eminengi yomhlabathi. ISpecific Ground Balance yenzelwa ukusetshenziswa emhlabathini otshisa kakhulu njalo iyasebenza kakhulu lamaMonoloop coil. IGB Off iyacitsha iground balance circuit umtshina wanelisa ukudingela ezingeni elitshonayo emhlabathini omuhle omnyama lasetshebetsheni etc.

ICustom Search mode (GPX5000)

Nxa kukhethwe iCustom, amaCustom Search Mode amanengi ayavela kuLCD menu. Kuba khona lemode name picker ekuvumela ukuziqambela awakho amaSearch mode endawo ezehlukeneyo ube usuzisebenzisa ngesikhathi esizayo.

AmaTiming

IGPX Series ilamanew timings amanengi, okuthuthukisa ukusebenza kwayo ezimeni ezehlukeneyo. iFine Gold, salt/Gold le Coin/ Relic ngamanew timing eGPX5000. iCoin/ Relic intsha lakuGPX4800.

IRx Gain

IRx Gain function isebenza ukuntshintshantshintsha amandla edetector yakho. Lapho okulomhlabathi omuhle ungakhweza/khuphula iRx Gain. Endaweni ezinzima iRx Gain ingehliswa

Motion – ukuhambahamba

Umjaho ohambisa ngawo icoil phezu komhlabathi ulokutsho esikhathini ongasithatha ukuthola okudingayo lokutshintshwa kweGround Balance. Ukuqondanisa umjaho wekuhambisa ikhoyili okuthokozisayo le Motion setting efaneleyo kuyehlisa umsindo njalo kuthuthukise amathuba akho okuthola okudingayo lanxa kukhatshana.

IResponse (GPX 5000)

IResponse function iyakuvumela ukuba untshintshe itarget response. Amatarget akhatshana usungawabamba ngomsindo ofana lalowo owamatarget aseduze.

IStabiliser

Istabiliser ikuvumela ukuthi uhlele ngokufaneleyo imisindo yomtshina ukuze wanelise ukwehlukanisa phakathi kwamasmooth operation lamatarget signal acacileyo.

ITarget Volume

Isetshenziswa ukulawula i-amplifier ephakathi komtshina eyiyo elawula umsindo wamatarget signal. Itarget volume ingasebenza lamaheadphone kumbe le speaker esingaphandle. Iyasetshenziswa njalo ukwehlisa umsindo wamaground signal.

6 | Ukuhlanganisa izingxenye zomtshina

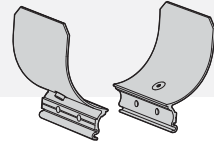

Armrest (2 sections)

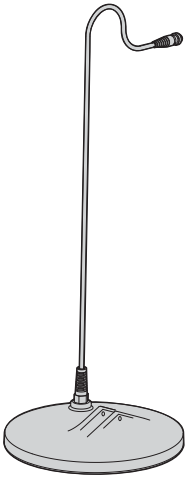

11" Coil

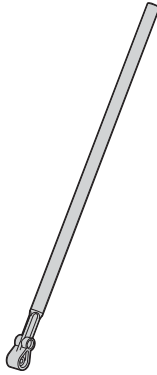

Lower Shaft

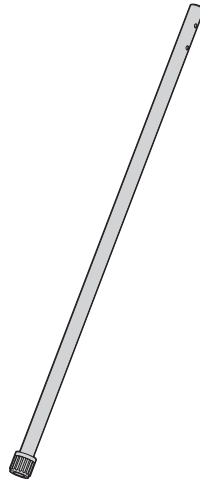

Upper Shaft

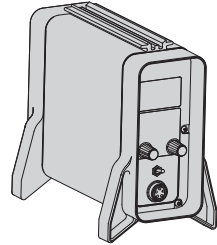

Control Box

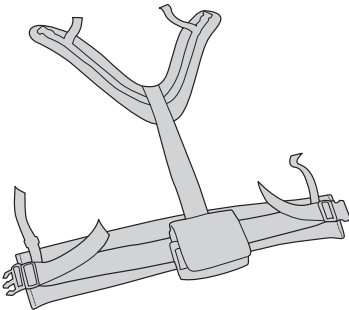

Battery Harness



Bungie Cord Clamp
(Bow Knuckle) with
Bolt and Wingnut

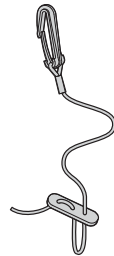

Bungie Cord

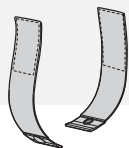

Armrest Straps

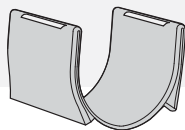

Armrest Cover

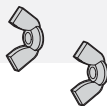

Armrest Wingnuts

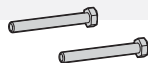

Armrest Bolts

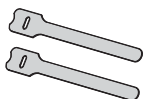

Velcro Tabs

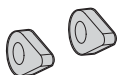

Lower Shaft Washers



Lower Shaft Wingnut



Lower Shaft Bolt

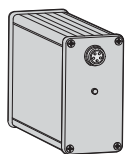

Lithium-ion Battery

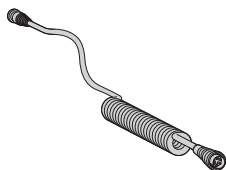

Power Cable

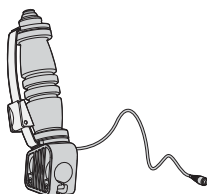
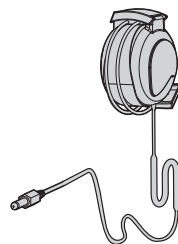
Handle
(with Quick-Trak
Button)

Headphones

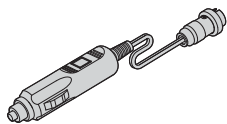

Vehicle Charger Adaptor

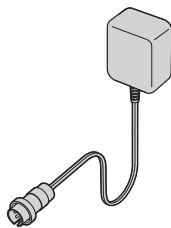

Mains Charger Adaptor

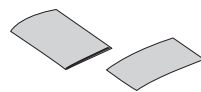
Instruction Manual
& Warranty Card

Ukuhlanganisa ikhoyili yelower shaft:

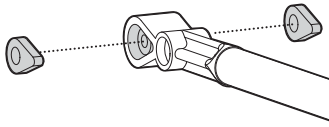

- 1 Hloma amarubber washer womabili ezikhaleni ezikumacele elower shaft.
- 2 Kumele ubone ukuthi iphini elespring yellower shaft ikhombele phansi. Hloma ilower shaft kubracket eliphezulu kwekhoyili.
- 3 Faka ibhawudo lihlanganise ilower shaft lebracket eliphezulu kwekhoyili. Bopha nge-nkinobho lakhona ngonanzelelo ukuze ungabulali amathread ngokubopha kakhulu. Kungadingeka ukuba kukululwe mihla ngemihla ukuze kuntshintshwe ikhoyili ibe kudetecting angle ethokozisayo.

Qaphela lokhu: Ikhoyili ingaqalisa ukuxeg ngemva kwesikathi, ungafaka marubber washers amatsha

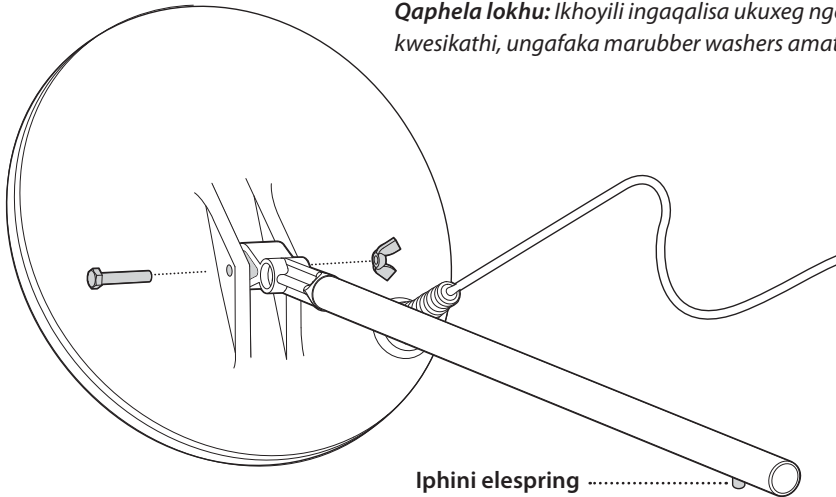

Iphini elespring



Ikhoyili ye cable igxunyekwe kukhoyili kayikhupheki ukuzama ukukhupha lintambo kuyasesula isethembiso sokulungisa umtshina wakho phakathi kwesikhatshana uthengiwe

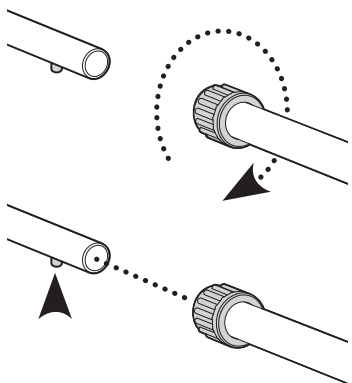

Ukuhlanganisa ilower shaft le upper shaft:

- 1 ITwist lock yeupper shaft ikhangele khatshana lawe, yitshilele phambili njengokuhamba kwewashi (clockwise) ukuze ivuleke.
- 2 Fithizela iphini lelower shaft elilespring. Hlohla ilower shaft ku upper shaft uyisunduze iphini ize ifike esikheleni (adjustment hole). Iphini izatshutsha kulesisikhala ukuze kubambane.
- 3 Bopha itwistlock ngokutshilela ngemuva (counter clockwise) ukuze ubambe ilower shaft ingagidagidi.

Ukufaka isibambo (handle) ku Upper shaft:

- 1 Faka ibungy cord damp ku Upper shaft.
- 2 Faka isibambo ku Upper Shaft sigobele katshana lawe, njengotshengiswe ngaphansi.

Ukuhlanganisa iArmrest leUpper Shaft:

- 1 Faka ingxenye zombili se-arm rest emaceleni e upper shaft uqondanise izikhala searm rest leze upper shaft
- 2 Hloma amabhawudo kuzikhala searmrest leze upper shaft.
- 3 Bopha amabhawudho kodwa kungaqini, ngama wing nuts (kuzabotshwa kuqine nxa icon control box isifakiwe).

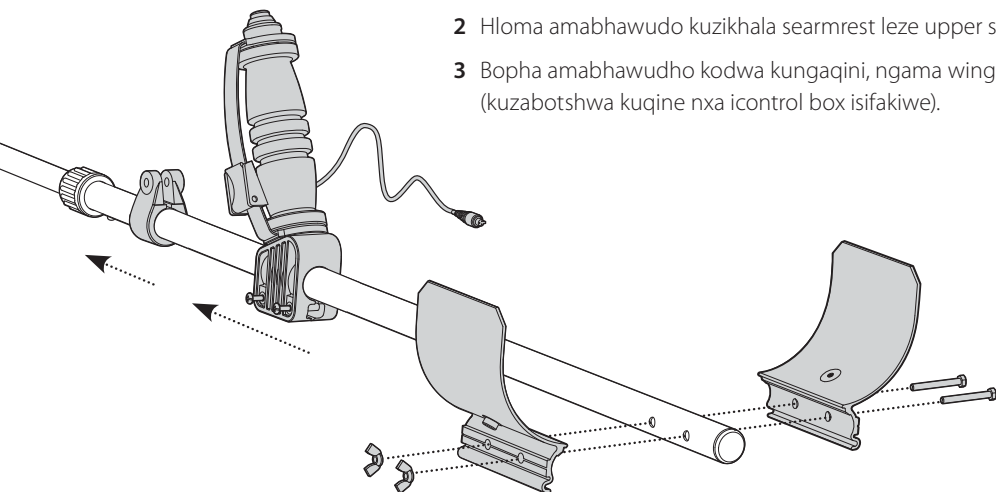

10 | Ukuhlenganiswa komtshina Kuyaqhutshwa...

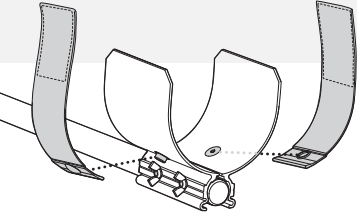

Ukufaka amaArmrest straps kuArmrest:

- 1 Fithizela izikopelo zamastrap womabili zibambe kulezo ezearmrest.
- 2 Ngenisa ama-armrest strap ezikheleni se-armrest cover ube usufaka iarmrest cover phezu kwearmrest.

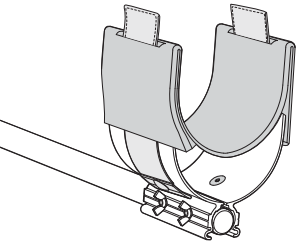

Ukuxhumanisa iconcontrol Box le Upper shaft:

- 1 Beka idetector lapho endaweni elingineyo, isibambo sikhangele phezulu.
- 2 IArmrest ibe phezu kwe control box.
- 3 Kopela iconcontrol box kuarmrest, ubone ukuthi amaplug ebattery awakhangelanga kukhoyili.
- 4 Bopha amawing-nuts aqine.
- 5 Thandela iQuick button cable kuUpper shaft ube usuyigxumeka kusmart point socket kucontrol box, ubone ukuthi intambo ithandelwe kuhle kodwa ungaphambanisi ikhanda eligxunyekwayo.

Qaphela: Uma iQuick-Tak cable ingayekethisa zama ukuyibophela kushaft ngentambo kagetsu.

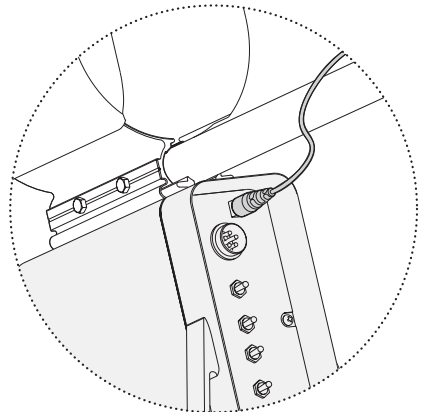
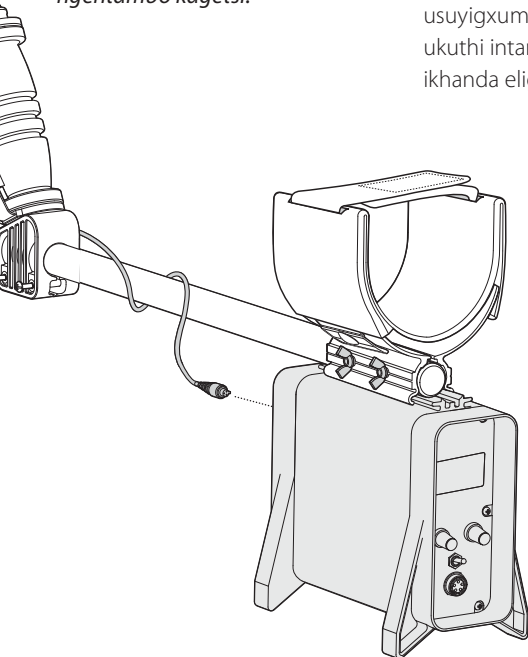



Kumele ubone ukuthi ngaso sonke isikhathi lapho ugxumeka kumbe ukhupha ikhoyili iconrol box icitshiwe ukuze ungabalali ikhoyili.

Ukugxumeka intambo yekhoyili (Coil cable):

- 1 Thandela intambo yekhoyili kulower le upper shaft ubone ukuthi ibambe yaqina. Ungatshiya ingathandelwanga kakhulu ngaphansi eduze lekhoiyili ukuze ikhoyili igobiseke nxa intshintshatshintshwa lapho umtshina usetshenziswa.
- 2 Sebenzisa amavelero strap ukubophela intambo le kushaft.
- 3 Gxumeka ikhanda lentambo yekhoyili kukhoyili socket kucontrol box, ubophe i-retaining ring ukuze kungatshuphuki.

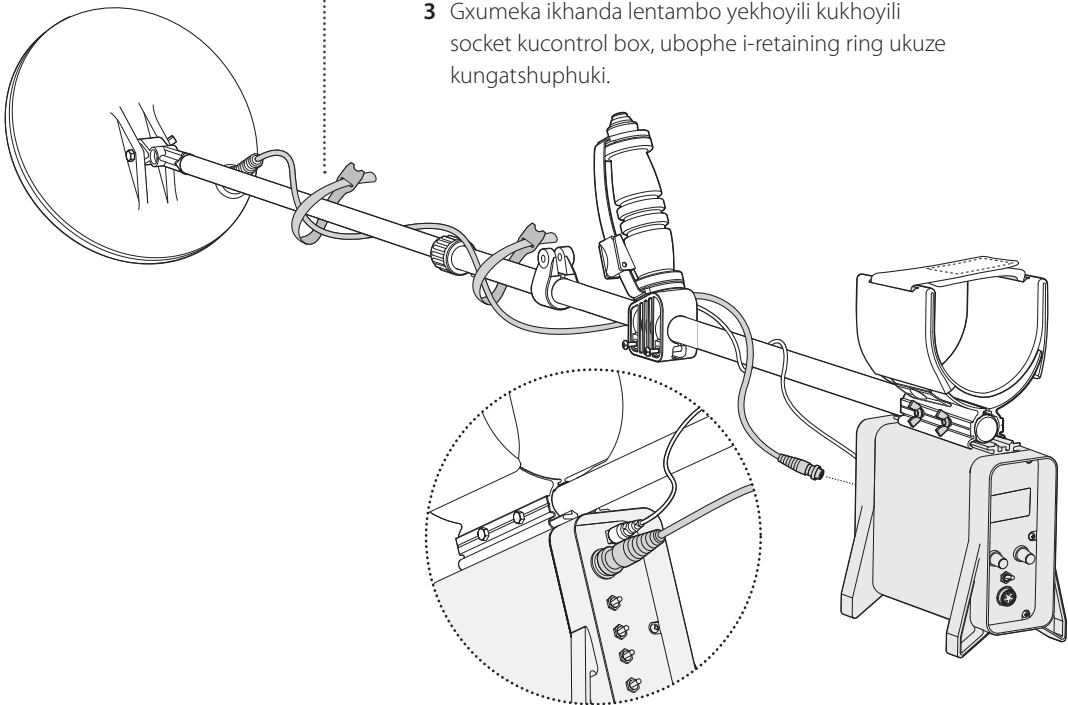

12 Ukuhlenganiswa komtshina Kuyaqhutshwa...

Ukugxumeka ibattery pack:

- 1 Faka ibattery kubattery harness poach.
- 2 Gxumeka la ama headphones lentambo yomlilo kuma socket ayiwo afaneleyo kubattery.

Okhuqakathekileyo:

Umzekeliso utshengisa ibattery elenzelwe osebenzisa idetector abambe ngesandla senxele.

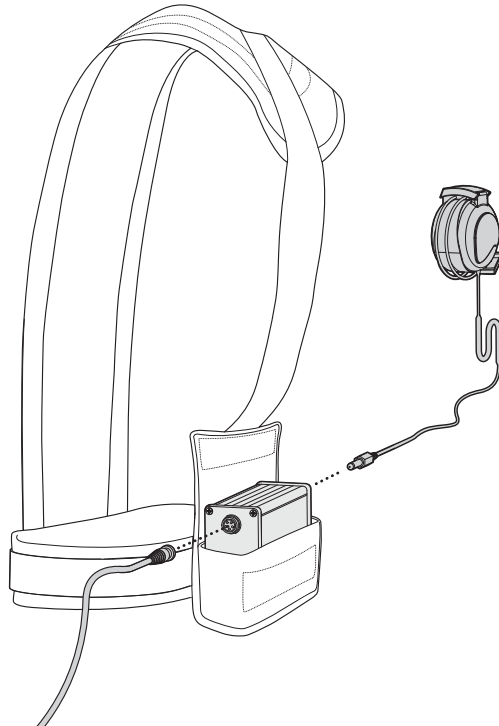

Isixwayiso: Ibattery elitsha kumele litshajwe okwamahola ayisitshiya galo mbili lingakasebenzi.



Isixwayiso: Ungaxhumanisi ama headphones akho ukuthi afane le speaker sangaphandle ngoba umsondo ungabaphezulu ungalimaza ukuzwa kwakho.

Qaphela: I market accessory booster akumelanga zisebenzisane le amplifier le eyakelweyo. Ngakonje, amalungiselo edetectors 'Target Volume' ivumela ukulungisa i-target signal volume le threshold, ngakho ama-accessory boosters kawavunyelwa.

Ukusebenzisa swa kwe Minelab Lithium-ion battery Amplifier:

Ukusetshenziswa kweLithium ion battery amplifier ye Minelab Lithium ion battery equkethe i amplifier ekhweza izinga lokuzwakala, yodwa ingancediswanga, nxa kungasetshenziswa kakuhle ispeaker esi wired.

IMinelab Lithium ion iyazizwela yodwa ingancediswanga nxa kusetshenziswa amaheadphones kumbe ispeaker njalo iphinde iguqule izinga lokwezwakala ngendlela.

Khangela okudwetshiweyo ngaphansi ukuze ubone indlela eqondileyo yoku xhumanisa ispeaker lokwezwakala andro.

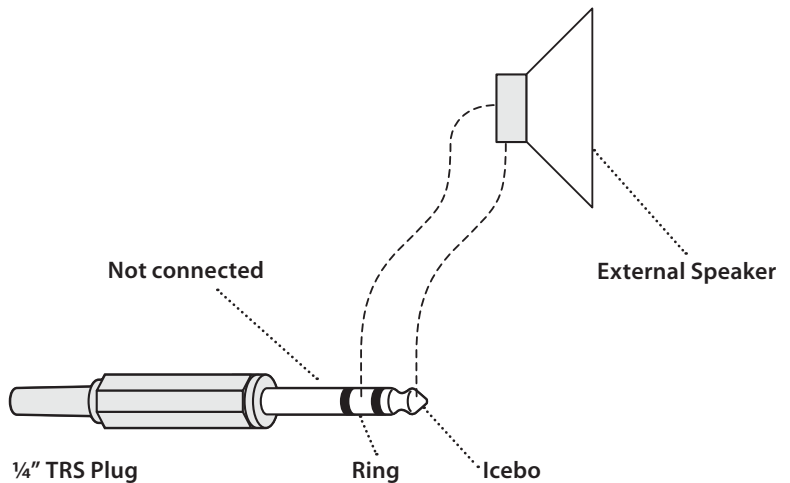

14 Ukuhlanganiswa komtshina Kuyaqhutshwa...



Ukulinganisa ugqoke ibattery harness – (okubamba ibattery):

- 1 Ngenisa ingalo zakho ku harness ukuze ibattery lihlale emhlane.
- 2 Hlanganisa ama buckles ekhandeni lesifubeni ndawonye.

Ukuthola okunengi mayelana lalokho bala ngokuguqulwa kwe detector ukuze udethekithhe kuhle kukhasi letshumi lesithupha.

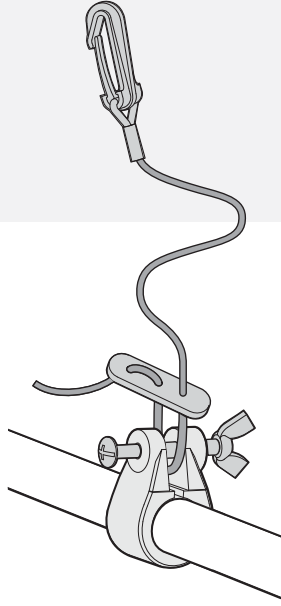

Ukugxumela iBungy Cord:

- 1 Yenza iloop engwegwa ku bungy cord.
- 2 Yekethisa iwingnut eyepulasitiki ukhiphe ibhawudo kuclamp.
- 3 Fuqela ibhawudo ulinganisa ku clamp lakungwegwa ukuze ibungy cord ihlale kuhle kushaft.
- 4 Bophela iscrew ku wingnut.
- 5 Xhuma intambo ye bundy cord kwezinye zamastrap rings amahlombe.

Ukuze uthole okunengi ngalokhu, bala kukhasi 16.

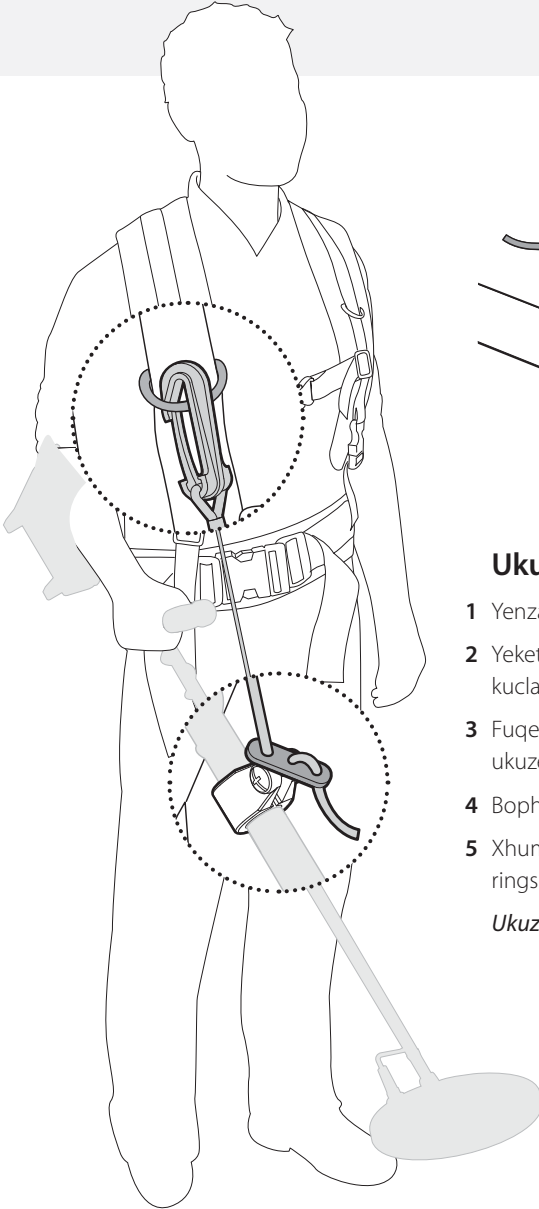

Ukulungiswa/ukuguqulwa kwe detector ukuze ihlale kuhleg

Qaphela: Ukuze udingisise, uhlaliseke, njalo okwesikhathi eside, kuqakathekile ukuthi uthathe isikhathi sakho untshintsha ulungisa idithekitha ngendlelay.



Ukubamba idetector:

Ngenisa isandla sakho kuarmrest abophe. Bamba isibambiso sedethekitha ubeke ingaphambili yesandla kuarmrest.

Ukutshuna ipozishini yesibambo:

Indololwane yakho kumele ihlale ngaphezulu kwangemva yalapho okuhlela khona ingalo ukuze wenelise isibambo endaweni yaso. Usebenzisa iscrew driver bopha iziscrew zombili ezibamba isibambo ukuthi singene kushaft. Ungatshintsha isibambo ukuze sibambe kahle.

Ukutshintsha ulungisa ubude lobufitshana be shaft yangaphansi.

Ukutshintsha ubude be Lower Shaft:

Nxa ikhoyili ikhatshana lomzimba wakho kuzabanzima ukuthi ume kuhle njalo uhambe lapho udethekitha.

Nxa ikhoyili iseduze lomzimba wakho inga dethekitha ipiki, ibattery kumbe ingqe yikuphi ongabe ukuthwele okwenziwe ngesimbi, lokhu kungenza kucine kusiba lemisindo engukuphambanisa wena.

Bhodisa amatwist locks aweshaft, ubhodisela kusandla sokhohlo – counter clockwise – ukuze ubone ukuthi asexega.

Fitzela ama spring pins aweshaft uwaphakhamisele phezulu kumbe phansi, ngokufuna kwakho. Nxa ama shafts onke ese banjanisiwe ahlala endaweni, bhodisa ama twistcodes kusiya esandleni sokudla (clockwise) engena kushaft aze angene abanjwe ska.

Ubude obuqondileyo be shaft yangaphansi kumele wenelise ukwelula ingalo yakho uyisele le lale phambi komzimba wakho kakuhle ukhulekile ungelalanga kakhulu kumbe ungananelanga.

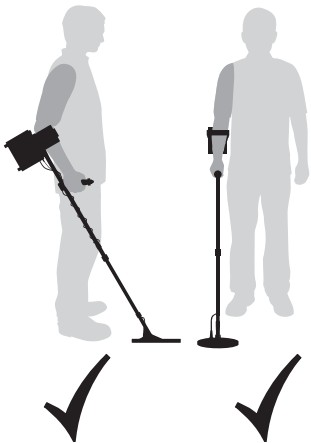



Icebo: Abanye abasebenzi bayahlaliseka ngokufaka ibattery ekhalweni. Kodwa kumele uqaphele ukuthi idithekitha ayiani inanzelela ibattery. Nxa usebenza ikhoyili enkulu, ibattery lakho kalihlalele phezulu emhlane lapho ozwa kuhlaliseka khona ukuze uxwaye ukuphambanisa.

Ukutshitsha ulungisa ibattery harness:

Ibattery harness engena ibambe ihlale kuhle iyenza ukudithekitha kube kude kungela kuphambaniseka.

Ibattery kumele libe semhlane ukuze ibhalanse ubunzima bedithekithakitha ungatshadisanga nzima iku bungy cord.

Ukuze ubophe mfi, donsela intambo phandle laphansi.

Ukuze kuyekethise, fuqela intambo zidlule kubhakili

Ukutshintsha ulungise ibungy cord damp:

Iharness iyatshintsheka ilungiswe isemzimbeni wakho ngokungenisa intambo zaphambili kumawuka eunkenayo awebhandi lokhalo.

Ubunzima be khoyili buthathwa yibundy cord damp eyabe ihleli yangena kushaft yekhethiswa idamp screw ukuze ingene kushaft. Yifake endaweni ezenza lawe osebenzisayo uzwe uhlaliseka.

Qaphela: Kungaba ledingeko yokuthi utshintshe ububanzi bebungy cord, kumbe indawo yebundy cord damp, nxa untshintsha ama khoyili kumbe udithekitha kundawo elomhlabathi oyehlayo.

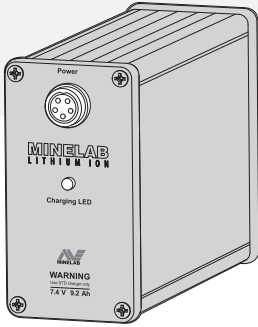

Icebo: kulelinye ibhatiri eliyabe likhona nxa uthenga. Nxa usiya emaphandleni kule battery elinye elizakwenza wenelise ukuthi udithekitho okwesithathi eside.

Aluminium battery case iqukethe i74v li-on battery pack le circuit yokutshaja yangaphakathi. Okubuya kule GPX5000 le GPX4800 yimains charger adapter le 12v charger adapter yemota.

Nxa litshajwe lagcwala, ibattery liyabe lilomlilo wokhulayitha idithekitha okungaba ngamahola angamatshumi lamabili.

Itshaja iyenelisa njalo ukutshaja ibattery elingelamlilo okwamahola amahlanu, kodwa amabattery alomlilo kancane athatha amahola amalutshwane. Asiko isidingo sokuqedaumlilo wonke kubattery le Li-ion ungakalitshaji, liyatshajwa futhi inqe yisiphi isikhathi ungadithekithi.

Qaphela: Amanye amakhoyili after marker ayaqeda ayamunyu umlilo webhatiri kakhulu okungenza isikhathi sokusebenza sehle ngezinga elingamapesentii angamatshumi amathathu 30%.



Isixwayiso: Ibattery elitsha kumele liqale litshanjwe okwammahola ayisitshiya galombili lingaka setshengiswa.

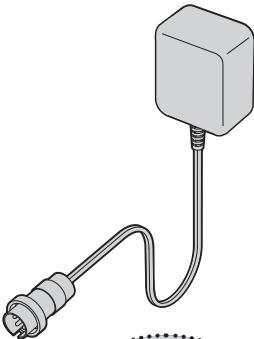

IMains Charger Adaptor

Mains Charger Adapter izatshaja ibattery kusuka kumains (AC) power outlets.

Ukutshaja nge mains charger adapter:

- 1 Khipha intambo yomlilo kubattery.
- 2 Xhuma imains charger adaptor kuplug yebattery loku socket emdulini.
- 3 Layitha isokhethi emdulini.

Umbala we tri-colour LED (ekukhasi 20) izakubonisa ukuthi kuyatshaja kumbe hayi.





Ukuze wenqabele ukukhubazeka kwebattery, ungavusi injini yemota lapho ibattery ligxunye kiwe.

Kumele ubone ukuthi ibattery lemota yakho lisesimeni esilungileyo ungakalisebenzisi ukutshaja ibattery leGPX series.

IVehicle Charger Adapter

IVehicle Charger Adapter ngeyokutshaja ibattery usebenzisa iaccessories socket (cigarette lighter) ezimoteni eziningi. Isocket leli kumele libe yi12-24VDC.

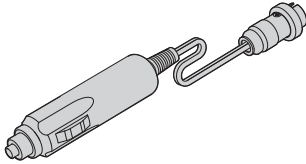

Ukutshaja ngevehicle charger Adapter:

- 1 Khupha intambo yepower kubattery.
- 2 Gxumeka ivehicle charger adapter kubattery ube usuyigxumeka kuaccessories socket emoteni.

Umbala wetri-colour LED (ikhasi 20) uzakutshengisa ukuthi ibattery selitshaje okungakanani.

Qaphela: *Ungatshiji ibattery litshaja emoteni evaliweyo nxa ilanga litshisa ngoba litemperature protected ngakho lingena ukutshaja.*

AmaLithium-ion cells ayaziwa ukuthi ayaphela amandla okubamba umlilo ngokuya kwesithathi. Lothu kwenziwa yizinto ezimbili:

Ukuganwa kwebattery (capacity fade on cycling)

Ukwehla kwamandla ebattery okubamba umlilo kubonakala lapho ibattery okubamba umlilo kubonekale lapho ibattery selihlala litshajiwe liphinde lilahle umlilo masinya (njengokwenzakala nxa lisesshenziswa lokhu yinto ejwayelekileyo, ebizwa ngokuthi yi-capacity fade, njani iyatholakala kuma Lithium-ion system amanengi kungakhathalekile ukuthi ibattery lenziwe ngaphi lasetshenziswa ngaphi.

Okunye okwehlisa amandla okubamba umlilo yikuvunyelwa kwebattery ukuthi liphele umlilo uze uphele du, lokwekelwa linjalo okwesikhathi eside lingatshajwa futhi. Futhi lokhu kufanele kwenqatshelwe ngazo zonke indlela ukuze amandla ebattery angalahleki lebattery lihlale isikhathi eside. Amadetector eMinelab ayazicitsha lapho umlilo usuphela ukuze ibattery lingapheli umlilo uze uphele du. Ibattery pack lona lile electronic protection circuit evikela ukuthi ibattery lingapheli du lapho kungaba le-short circuit ibattery lingagxanyakwanga kedetector. Ukutshaja ibattery ngemva kokusetshenziswa laphose laphela, lingatshiywa lingelamlilo, kuyancedisa ukwehlisa amatumba ecapacity face.

Impilo ye battery

ILithium-ion battery elidala ngeke lahlala isikhathi esifana lesebattery elitsha. Lokhu kungenxa yokukhwela kwe internal resistance okuphambanisa amandla abo okuphila umlilo.



Ngokwejwayelekileyo

<i>Umbala oyired-orange-green: (Obomvu lolithanga loluhlaza) Obhoda kancane kancane</i>	Ubonakala lapho: ithuba lityitha
<i>Umbala olithanga: (solid orange)</i>	Ibanga lokucina lokutshaya
<i>Okuluhlaza: (orange with A blink of green)</i>	Ibanga lokucina lecharge
<i>Umbala oluhlaza: (solid green)</i>	Ibattery selitshaje lagcwala

Ongakukhangelela

<i>Umbala obomvu ocwayizayo kancane (slow blinking red):</i>	Ibattery litshisa kakhulu. Selifikile ku 500C (1220F) ngakho alisatshaji. Khupha ibattery kucharger umelele ukuthi liphole libe ngaphansi kwe400C (1040F) endaweni epholileyo ungakalibuyiseli kucharger.
<i>Umbala olithanga ocwayiza kokuphela (continuous orange blinking):</i>	Ibanga lokuqala lokutshaja selidhlulilee. Lokhu kungaqhubeka kusenzakala ngaso sonke isikhathi ibattery litshajwa, kutsho ikuthi ibattery alisasebenzi kuhle. Ungathintana labakuthengiselayo.
<i>Umbala obomvu (solid red):</i>	Ibattery alisebenzi kuhle. Likhuphe uphinde ulibuyisele kucharger. Nxa iLED ilokhu ibomvu thintana labakuthengiselayo.



Lithium-ion battery lenzelwa iGPX series.

ILithium-ion battery alisebenzi kwamanye amadetector angaso GPX Series. IGPX5000 le GPX4800 kuthengiswa kulepower lead eyenzelwa amaGPX Series detector kuphela. Ukuzama ukusebenzisa iLithium-ion battery pack kwamanye amadetector kungabulala idetector loba ibattery pack. Ungazami ukusebenzisa lelibattery kweminye imihlobo yamadetector ngoba lokhu kungawakhubaza.

- Ungatshaji ibattery elitshisa ngaphezu kwe45°C (113°F).
- Ungatshaji ibattery eliqanda ngaphansi kwe0°C (32°F).
- Ungatshiyi ibattery lapho okutshisa khona (isibonelo: kudashboard kumbe kuparcel shelf esemuva kwemota).
- Ungacwilisi ibattery kuloba yiwuphi umhluzi njalo ungavumeli lingenwe ngamanzi.
- Ungaliphonsi ibattery kumbe ulibotoze.
- Ungatshisi (short-circuit) ibattery.
- Ungasebenzisi ibattery elikhubazekileyo.
- Ungehlukanisi ibattery kumbe uzame ukulakha kutsha.
- Ungalitshisi ibattery (burning).

Nxa ibattery lingasebenzi kuhle, kumele ulibisele kuservice centre esebenzisana leMinelab ukuze lilungiswe. Ukusetshenziswa kwezinto ezingavumelekanga kuyacitsha isiVumelwano sokulungiselwa mahala (warranty). Akukho ongazilingisela khona kubattery pack.

22 Okuqakathekileyo ngokudetector

Qaphela: AmaGPX Series detector ngamamotion detectors okutsho ukuthi asebenza ngokuhanjahanjiswa lokhu kutsho ukuthi ikhoyili kumele ibe ihambe phezu kwetarget kumbe, target ihamba phezu kwekhoyili ukuze ibanjwe yidetector.

AmaGPX Series detector asebenza kuhle kakhulu nxa ikhoyili ihlala iseduze lomhlabathi ngaso sonke isikhathi. Lokhu kukhweza amandla okubamba izinto ezikhatshana letarget response entweni ezincane.

Umahluko we height ye khoyili kubangela ukuthi kubelokuphambana kwemsindo engalinganiyo, manazwelo angafaniyo, ngakho kumele kubesipatalala.

Ukutshiyana kwepozishini yekhoyili ngemva kokuhweba ikhoyili phezu komhlabathi kudala imisindo elidayo kabanzi ngaphambi kwebanga okuhweba ngalo ukuze ubone ukuthi uhlole indawo enkulu. Ukuhweba kwakho kungaba imizwana emine (average 4 seconds) kusuka esandleni sokunxele kusiya kwesokudla kubuyela njalo kwesokunxele.



Icebo: Nxa usebenzisa iMondoop khoyili kumele uhwebe kabanzi ukuze ungakhuthi amatarget akhatshana (bona ikhasi 83) kulesibonelo sama search phetheni (search patterns).

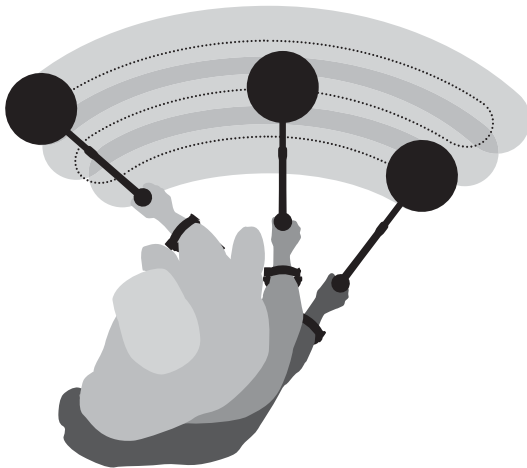

ITarget Response (Metal Object Response)

Lokhu yikuntshintsha komsindo we Threshold lapho itarget ibanjiwe njalo engaliwanga ngumtshina (rejected).

IThreshold (Background sound)

Lo ngumsindo ozwakala kudetector. Nxa kubanjiwe itarget, umsindo weThreshold uyantshintsha. Lalela iThreshold ngonanzelelo olukhulu. Itarget ekhatshana loba encane ingenza untshintsho oluncane kuphela kuThreshold.

Impambaniso yogetsi (Electrical interference)

Idetector ingenza imisindosindo lanxa ikhoyili izimele. Lokhu akusiwo matarget signal, kodwa ngamasignal enziwa ngumumo womhlaba. IGPX Series zile Tune (ikhasi 31) function yokwehlula impambaniso yogetsi.

Imisindo yomhlabathi (Ground Noise)

Enye inotho eyenziwa phansi ingenza idetector yenze imisindo eminenginengi, eyandiswe ukuthiwa ngama false signal. IGPX Series zile Ground Balance function (ikhasi 38) ezintshintshayo emisana lalinotho iphinde yehlule limisindo yomhlabathi.

Blanking (Ukubhulenk)

Nxa idetector ikulron Reject mode ingahweshwa phezu kweferrous target:Threshold iyathula (blanks) itshengisa ukuthi itarget ingaphansi kwekhoyili kodwa yaliwe ngumtshina. Ukuthula kweThreshold yindlela eluncedo yokwehlukana phakathi kwamatarget afunekayo langafunekiyo.

Umlilo omlutshwane kubattery

Uma ivoltage yebattery isehlile (p.51) kubale iseries zama alarm aphumayo ngemva kumzuzu omnye namunye.

IControl Panel yangaphambili (Front)

GPX4800

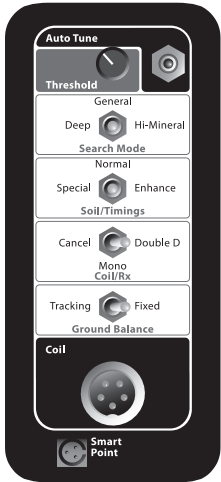

GPX5000

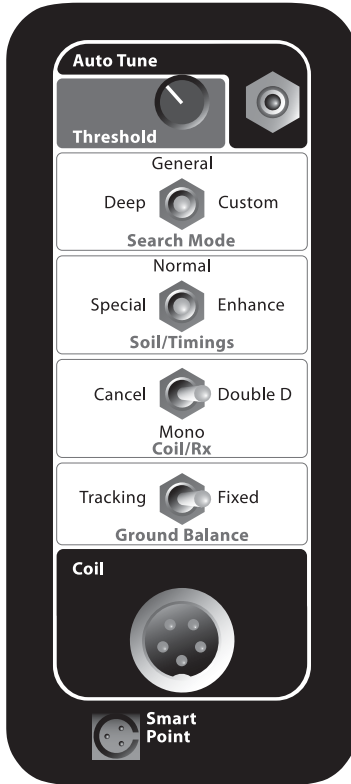

Auto Tune (ikhasi 32) iyaziskanela (automatically scans) amafrequency channel akhethekileyo ukuze incedise ukwehlisa impambaniso yogetsi.

IThreshold (ikhasi 33) ngumsindo owenziwa yidetector lesisilawulo siyakhweza kumbe sehlise izinga leThreshold.

ISearch Mode (ikhasi 28) Imode yinye ngayinye ilama factory preset setting afanele indlela zokusetsha. Amasearch mode angalungiswa ukuze afanele izimo ezehlukeneyo zokudinga igolide.

ISoil/Timings (ikhasi 35) ikuvumela ukuthi untshintshe amaelectronic pulse/amatiming edetector ukuze kwengezwe amandla okusebenza kumihlobo eyehlukeneyo yomhlabathi lakumatarget ayimihlobo eyehlukeneyo.

Ikhoyili /RX (ikhasi 36) ikuvumela ukuntshintsha amatransmit le receive (RX) Field ekhoyili.

IGround Balance (ikhasi 38) kumisana lemihlabathi elenotho enengi endaweni ehlo wayo

IKhoyili ihlanganisa ikhoyili lebhokisi lezilawulo (Control box).

ISmart Point yindawo exhumana le Quick Track button etholakala esibanjani (ikhasi 41)

GPX Series

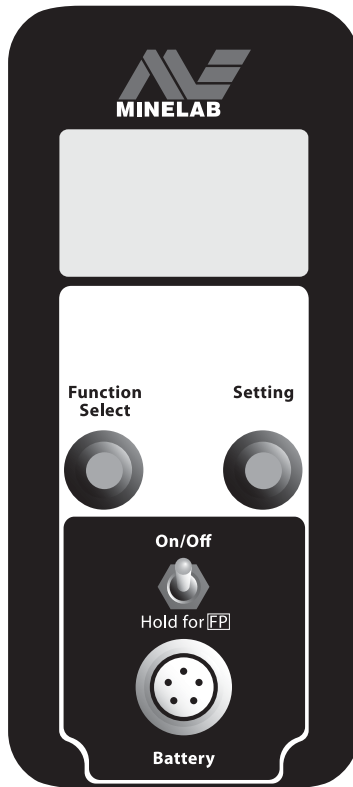

LCD (Liquid Crystal Display)
Itshengisa amafunction lamasetting akumenyu. Isilesibane sangemuva (backlight) (ikhasi 50).

Function select (ikhasi 48)
ikuhambisa phansi kumbe phezulu kuluhlu lwamafunction (functions list).

Setting (ikhasi 49)
Lapho ifunction isikhethiwe amasetting akuvumela ukuthi untshintshe ukusebenza kwayo.

On/Off (ikhasi 26)
iyalayitha idetector ikuvumele ukuthi ubuyisele ama Factory Preset (Qhubeka ubambile kuze kube kuFP).

Battery
lihlanganisa ibhokisi lezilawulo (control box) lebattery lama head phone.

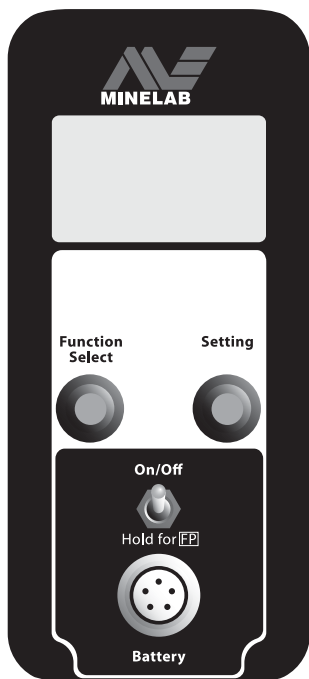

iOn/Off switch itholakala kuControl Panel yangemuva.

Ukulayitha lokucitsha idetector:

- 1 Fithizela iON/Off switch bese uyekela.
- 2 Kuzavela umfanekiso wokukwamukela olotshwe inombolo yeGPX Series model yedetector yakho.



Kuqakathekile ukuthi nxa ulayitha idetector yakho ube uphandle, khatshana lezinto ezingenza kumbe lokuphambaniseka kwegetszi ezinjengentambo zegetszi, ucingo olulegetszi lemiphongolo yamafoni. Lezizinto zingenza idetector ingasebenzi kuhle, yenze amaFalse signal amanenginengi.

Qaphela: Nxa idetector isenza ioverload sound, susa ikhoyili duze lensimbi ezinkulu. Ioverload kayikhubazi ukusebenza kwedetector.



Ungabolayitha ucitsha idetector njalo njalo. Lokhu kungenzakala, kuyavela umfanekiso olotshwe coil over current. Citsha idetector ube usulinda okwesikhatshana ungakayilaithi futhi.

Amafuction amanengi eGPX series atholakala ngokukhangela kuLCD menu. Lamafuctions achazwe kakuhle emakasini alolugwalo alandelayo.

Amafuction ahlelwe ngaphansi kwe “Main Menu” ayatholakala kuyo yonke imitshina njalo ayasebenziseka kuwo wonke amasearch mode. Amafuction ahlelwe ngaphansi kwesearch mode ekhethiweyo (isibonelo “General” njengo kusemfanekisweni) ngamasetting akhethekileyo asebenza lamasearch mode akhethiweyo.

Nxa ungakayejwayeli iGPX 5000 loba iGPX 4800, ungasebenzisa idetector ngamafactory preset (ikhasi 46) lecontrol panel yangaphambili (front) (ikhasi 24).

Amafuction eGPX 5000

<u>MAIN MENU</u>	▼
BACKLIGHT	2
BATTERY TEST	
VOL LIMIT	12
GB TYPE	GEN
SPECIAL	FINE
MAN TUNE	128
<u>GENERAL</u>	◆
MOTION	SLOW
RX GAIN	11
AUDIO	NRM
AUDIO TONE	50
STABILIZER	10
SIGNAL	16
TARGET VOL	8
RESPONSE	NRM
TRACKING	MED
IRON REJECT	OFF

Amafuction eGPX 4800

<u>MAIN MENU</u>	▼
BACKLIGHT	2
BATTERY TEST	
VOL LIMIT	12
GB TYPE	GEN
SPECIAL	EXTRA
MAN TUNE	128
<u>GENERAL</u>	◆
MOTION	SLOW
RX GAIN	8
AUDIO	NRM
AUDIO TONE	50
STABILIZER	5
SIGNAL	16
TARGET VOL	8
TRACKING	MED
IRON REJECT	OFF

GPX 5000 Range
GPX 4800 Range

General, Deep, Custom (Patch, Hi-Mineral, Hi-Trash, Pinpoint)
 General, Deep, Hi-Mineral

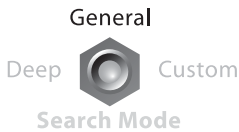

IGPX4800 BV ilamasearch mode switch pozishini amathathu: iDeep, General leCustom. ICustom iyakuvumela ukuvula amanye amasearch mode amane usebenzisa ipanel langemuva leLCD menu.

Isearch mode swith pozishini yinye ngayinye ilamafactory preset setting ukuze wenelise ukuhle uqale ukudinga ngawo. Nxa usuyejwayele IGPX series, ungawalungisa amasetting ngokuthanda kwako ukuze afanele izimo ezehlukeneyo zokudinga inotho.

IGeneral

IGeneral mode ikunika amandla amakhulu okubamba itarget, lesignal response njalo imisindo yedetector ayiphambaniseki. Amandla okubamba amatarget akhatshana aphezulu njalo asezingeni eliphezulu lokuhlola. Ngezizatho lezi, kukhangelelekile ukuthi iGeneral ibe yisearch mode yakho yakuqala, lawa amanye asebenze endaweni ezikhethekileyo.

IDeep

IDeep mode kumele isetshenziswe lapho uhlola indawo encane ngeziqubu esincane njalo ngonanzelelo njengodinga amanugget lapho okwehle khona. iDeep mode ilungiselwe ukuhweba ngesiqubu esincane ukuze ubambe amatarget akhatshana amakhulu.

IHi-Mineral (GPX 4800)

IHi- Mineral mode izakunceda ukuthi idetector ingaphambaniseki emhlabathini olenotho enengi njalo ihlale ilungele ukubamba amatarget amancane lakhatshana. Kungadingeka ukuthi untshintshe iRx gain setting ukuze ilungele indawo ethile.

Amafunction eMain Menu ayafanana kumasearch mode wonke.

GPX 5000

MAIN MENU	
BACKLIGHT	2
BATTERY TEST	
VOL LIMIT	12
GB TYPE	GEN
SPECIAL	FINE
MAN TUNE	128

GPX 4800

MAIN MENU	
BACKLIGHT	2
BATTERY TEST	
VOL LIMIT	12
GB TYPE	GEN
SPECIAL	EXTRA
MAN TUNE	128

Amafunction esearch mode yinye ngayinye angagcinwa kumasetting ehlukeneyo.

GPX 5000

GENERAL	
MOTION	SLOW
RX GAIN	11
AUDIO	NRM

DEEP	
MOTION	V SLOW
RX GAIN	12
AUDIO	DEEP

PATCH	
MOTION	MED
RX GAIN	8
AUDIO	BOOST

HI-MINERAL	
MOTION	MED
RX GAIN	8
AUDIO	NRM

General
 Deep  Custom
 Search Mode

General
 Deep  Custom
 Search Mode

General
 Deep  Custom
 Search Mode

HI-TRASH	
MOTION	MED
RX GAIN	12
AUDIO	QUIET

PINPOINT	
MOTION	V SLOW
RX GAIN	16
AUDIO	BOOST

Qaphela: ICustom search mode switch pozishini ikuvumela ukuthi uvule amanye amasearch mode angavuleka ngokukhangela kuLCD (Ukuntshintsha amasearch mode, kukhasi 60).

Amafunction esearch mode yinye ngayinye angagcinwa kumasetting ehlukeneyo.

GPX 4800

GENERAL	
MOTION	SLOW
RX GAIN	8
AUDIO	NRM

DEEP	
MOTION	V SLOW
RX GAIN	9
AUDIO	DEEP

HI-MINERAL	
MOTION	MED
RX GAIN	6
AUDIO	NRM

General
 Deep  Hi-Mineral
 Search Mode

General
 Deep  Hi-Mineral
 Search Mode

General
 Deep  Hi-Mineral
 Search Mode

30 Amasearch mode

Ayaqhutshwa...

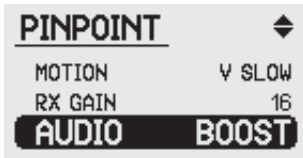
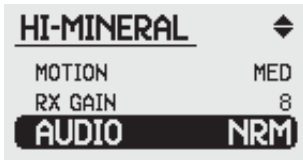
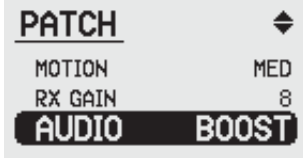

ICustom (kuGPX 5000)

Icustom mode search mode ikunika ithuba lokhukhetha kwamanye amasearch mode amane (ikhasi 60) atholakala kuLCD menu.

Lamasearch mode yila:

- iPatch (*Factory Preset Selection*)
- iHi-Mineral
- iHi-Trash
- iPinpoint

Lokhu kufaka inani lamasearch mode kwayisithupha engakhethwa ezineni ezehlukeneyo.

IPatch

IPatch mode ikhethwa nxa uhlola umhlabathi ongaziwayo, uhamba ngesiqubu esikhulu udinga inugget lakuqala elingakutshengisa indawo edinga ukuhlolisiswa.

IHi-Mineral

Bona ikhasi 28.

IHi-Trash

Li-mode ilamafactory preset akhethelwe ukuhlola umhlaba olengcekeza enengi. I-iron reject (ikhasi 72-75) setting ifakwe yaba phezulu ngakho ungayehlisa lapho ufuna ukuhlola ngonanzelelo.

IPinpoint

Li-mode yenza umsindo omkhulu ozwakalayo nxa ibamba itarget elike labanjwa kweyinye isearch mode. Isebenza kuhle kumatarget response azwakalela khatshana.

Amacustom search mode la ungenelisa ukuwetha amagama amatsha(ikhasi 76).

Ukutshunwa(Tune)

Ukwehlisa impambaniso yogets.



Icebo: Nxa ufuna ukwazi ukuthi yiphi ichannel ekhethiweyo ngemuva kweAuto Tune, dinga kumfanekiso weManual Tune ukhangele inombolo elotshwe lapho.

Idetector ingaphanjaniswa yimpambaniso yegets. evela ezulwini elinengi lezinye izimo zomkhathi, kuntambo zikagetsi, kumaradio, kuzinto ezisebenzisa igetsi loba amanye amadector asetshizwisayo aseduze (Bona isibalo sengcazelo esikukhasi 89 ukuze uthole okunye okuphathelane lempambaniso[interferences]. Impambaniso le yenza umsindo weThreshold ongathokozisiyo.

Ukuze idetector ingaphanjaniswa yilutho, iversearch channel ingantshintshwa ngokubotoza kuManual Tune Setting kuLCD menu kumbe izintshitshe yodwa isebenzisa ibhathani leAuto Tune kucontrol panel.

IAuto tune yeluleka idetector ukuthi izikhethela ichannel elungele umsebenzi ngemva kokuhlola wonke. Ukutshuna ngeAuto Tune kungathatha imizuzwana efika kwengamatshumi ayisithupha.

IManual Tune setting, etholakala kuLCD menu iyakuvumela ukuthi ukhethela ichannel yinye ngayinye ulalela ukuthi akulampambaniso, bese ukhetha.

Ichannel elungele ukukhethwa yileyo etshengisa impambaniso ezilutshwana (isibonelo: intambo zikagetsi).

Kuqakathekile ukutshuna ikhoyili ekhatshana lomhlabathi njalo umi endaweni eyodwa. Lokhu kunika idetector ithuba lokuzwa zonke impambaniso ezikuleyondawo (ezingaphathelananga lomhlabathi lamatarget) bese kukhethwa ichannel efaneleyo, engelamsindo.

Qaphela: Impambaniso ezikwezinye indawo zingantshintsha indlela oyikhethela ngalelolanga ngakho kuzafanele ube utshuna ngemva kwesikhathi ukuze iThreshold ihlale isesimeni esithokozisayo lapho uhlola indawo.

Kule Tune setting eyodwa nje. Ukutshintsha okwenzayo (manually) kwenza iAuto selection ingasasebenzi ngaleso sikhathi.

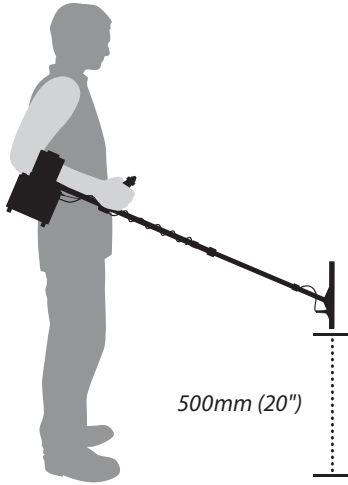

500mm (20")



Qaphela: ukutshuna kumele kwenziwe ekuqaleni iswitch yekhoyili ikuDouble D Kumbe kuMono. Nxa kulokhu kulempambaniso enkulu ngemuva kokutshuna, ntshintsha iswitch yekhoyili uyifake kucancel bese utshuna kakutsha nxa kudingeka.

Ukwenza iAutomatic Tune:

- 1 Bamba idetector ilingane laqolo lakho, ikhoyili ikhangele phansi, bese uyibhodisa ngesigombolozana. Ubone ukuthi akulamarget amakhulu loba okungenza kube lokungaphambanisa eduze.
- 2 Khangela lapho okulempambaniso ezinengi ubambe ikhoyili inganyikinyeki. Nxa usehluleka ukubamba idetector inganyikinyeki okwemizuzwana engamatshumi ayisithupa, ibeke phansi ikhoyili ikhangele phansi.
- 3 Botshoza ibhatani leAuto Tune. Bona ukuthi idetector ayinyikinyeki lapho izidingela ichannel.

Ukubhipha kanye kutsho ukuqala kweAuto Tune. Idetector izaqala ukuhlola ichannel yinye ngayinye idinga impambaniso ezilutshwana; impumela yokuhlola iyatshengiswa kuLCD. Lokhu kungathatha imizuzwana efika kwengamatshumi ayisithupa(60sec).

Idetector izakhetha ichannel engalamsindo etholakeleyo. Ukucina kohlelo lokutshuna kuzwakala ngokubhipha kathathu.

Qaphela: lapho kutshunwa idetector iseduze lamanye amadetector, abawasebenzisayo kumele banikane amathuba okutshuna, lingazami ukutshuna amadetector wonke ngasikhathi sinye.

Impambaniso ngayibona kuhle ungakhweza imotion setting(ikhasi 62). Ngakho ungancedisa iAuto Tune ekukhetheni ifrequency engelamsindo ngokufaka kuFast(GPX 5000), kumbe Medium(GPX 4800). Motion ungakaqali uhlelo leAuto Tune. Nxa loluhlelo seluphelile buyisela kusiqubu seMotion osithandayo.

IThreshold

Ukunsthinsha ibanga lomsindo ozwakalayo.



IThreshold ngumsindo ozwakaleka khatshana ophuma kudetector. IThreshold yiyo ekutshela ukuthi ikhoyili ibambeni; kungaba yitarget; umsindo womhlaba(ground noise) kumbe impambaniso yegets i ngakho kuqakathekile ukuthi iThreshold izwakale ngaso sonke isikhathi.

Ibanga lokuzwakala kwethreshold lingaba phansi kodwa izwakale kuhle ingelakuphambaniseka. Nxa ingazwakali ungaphambanisa ukufaka amanye amasetting edetector.

Amatarget amancane lamakhulu akhatshana angangabangi umsindo ozwakala kuhle kodwa enza kube khona inguquko kuThreshold. Nxa iThreshold iphezulu kakhulu kumbe iphansi kakhulu,inguquko le ingangezwakali. Ukulalela itarget signal kuThreshold ephezulu kufana lokuzama ukunyenyeza endlini elabantu ebanengi lomsindo omnengi. IThreshold ephezulu ingamphambanisa lokuzwa kwakho.

Nxa iThreshold yenziwe yaba phansi kakhulu, itarget signal yona kumele yenze umsindo omkhulu ozakwenza izwakwale. Ngakho—ke amatarget signal aphilolileyo angange zwakali.

Kuqakathekile ukuthi untshintshe izinga lethreshold lapho isimo odinga kiso sintshintsha. Isibonelo: indlebe zakho zingaqala ukuzwa imisindo ephansi ngemva kwehola kusiya phambili kumbe kuqale ukuphephetha umoya.

Kuqakathekile uku riseta iThreshold level mgokuchintsha komumo. Njengalokhu, indlebe zakho ziyakwanisa ukuntshintsha ngemva kwehola noma ngokuntshintsha komumo.

34 | IThreshold iyaqhutshwa...

Nxa iThreshold iphezulu kakhulu, isitshengiselo esincane ungeke usizwe. Kungazwakala isishlothi nje sesitshengiselo esikhulu.

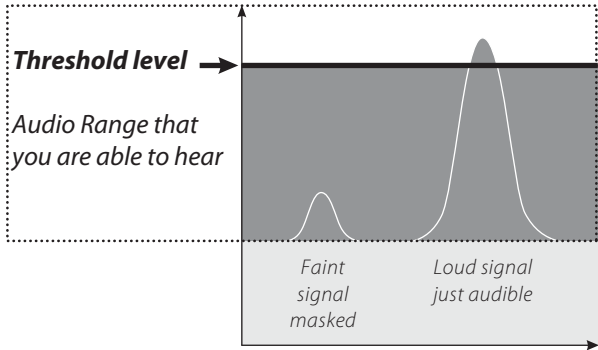

Nxa iThreshold itshunwe kuhle zonke izitshengiselo ziyezwakala kuhle.

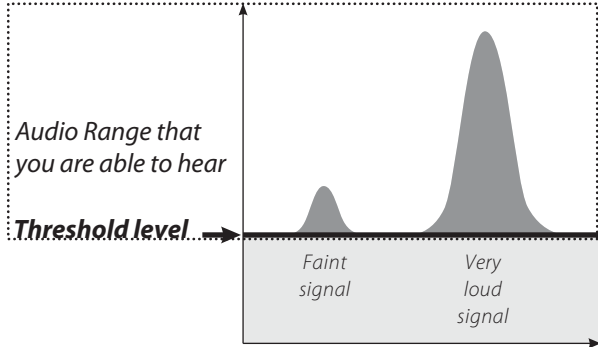

IThreshold ephansi kakhulu layo yenza izitshengiselo ezincane zingezwakali.

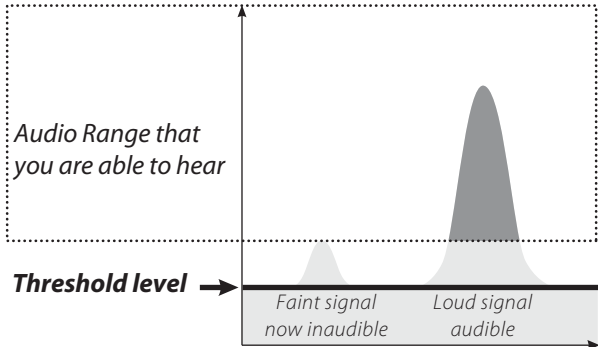

Soil/Timings

Ukwenza ukuthi umtshina usebenze kuhle emihlabathini lasematsheni ahlukeneyo.

GPX 5000 Range

GPX 4800 Range

Factory Preset

Normal, Enhance, Sens Smooth, Fine Gold, Sens Extra, Salt/Gold, Sharp, Coin/Relic

Normal, Enhance, Sens Extra, Sharp, Coin/Relic, Salt-Coarse

Special: Fine Gold (GPX 5000); Sens Extra (GPX 4800)



Qaphela: Nxa u-switcher phakathi kweSoil/Timinga kulomzuzo omncane kungakabi le-detection.

AmaTiming emitshina yeGPX achaza izmilo ze Transmitter (Tx) le Receiver (Rx). Inkinobho ye Soil/Timings yenza wenelise ukukhetha iTiming oyifunayo phakathi kwamanengi. Lokhu kwenza umtshina uzilungisele ukusebenza kuhle emihlabathini eminengi ehlukeneyo, umhlobo wekhoyili estshenziswayo lobukhulu bamatshe ofuna ukuwadinga. AmaSoil/Timings angenza ukuthi uthole okungcono.

Amanye amaTiming alobudlelwano obuthize leminye imihlobo yomhlabathi (lemaginethi, isimuny, endikindiki, njalonzalo), lasematsheni aligugu ehlukeneyo ngobukhulu bawo lezinye nje insimbi. Ngokusebenzisa inkinobho yeSoil/Timings ungaguquka ukusebenza komtshina ukuze usebenze kuhle ezindaweni ezehlukeneyo.



Normal

UNormal uzakusebenzela kuhle emihlabathini eminengi eyehlukeneyo, njalo izakupha ukujula okuhle kakhulu emetsheni alobukhulu obehlukeneyo. Isebenza kuhle kakhulu lamakhoyili eDouble D ekuzingeleni. Hlala usebenzisa uNormal ezindaweni ezintsha lapho ongelaqiniso khona lobunengi bamatshe aligugu kanye lokujula kumbe ubukhulu bamatshe lawo.



Enhance

UEnhance usebenza kakhulu ekuvaleni izitshengelo elethwa ngumsindo womhlabathi, njalo iyehlisa kakhulu umsindo wamadwala atshisayo. Isebenza kuhle kakhulu lamakhoyili eMonoloop emhlabathini yonke ngaphandle kwaleyo emibi okudlulisileyo. Ibukhali kabi ematsheni alobukhulu obutshiyetshiyeneyo.



Special

USpecial (p57) yinkinobho yokukhetha amanye nje amaTimings ongawathola kumenyu ekuLCD. Ungakhetha kula: iSensitive Extra, Sharp, Com/Relic le Salt-Coarse (GPX 4800 kuphela). KuGPX4800, leFine Gold, Smooth le Salt/Gold ku GPX5000.



Uhlele ukhumbula ukwenza iGround Balance nxa kulenguquko oke wayenza kunkinobho yeSoil/Timings.

Coil/Rx

Ukuguqula imikhandlo yeTransmit (Tx) leReceive (Rx) yekhoyili lohlobo lweDouble D.

GPX 5000 Range

Cancel, Mono, Double D

GPX 4800 Range

Cancel, Mono, Double D



Isiqondiso seCoil/Rx siguqula indlela yokudinga lobukhali bekhoyili. Lokhu kwenza kube ngcono ukusebenziseka lesimilo semitshina yeGPX lamakhoyili wohlobo lweCommander Double D. Lokhu kwenzeka ngokuguqula indlela okuhamba ngayo iTransmit (Tx) leReceive (Rx) y4e khoyili, lokuthi ibhokisi lokuqondisa umtshina lithola umbiko othini. Indawo yonke onga qondisa kiyo inkinobho uguqula iElectro magnetic field yekhoyili, okungayenza umtshina usebenze ngcono kwezinye indawo.

Amakhoyili angalungiswanga yiMine lab angasebenzi kuhle kumbe angasebenzi kokuphela nxa uthe waqondisa inkinobho kuMono kumbe kuCancel.



Kuyadingeka ukuthi wenze kutsha iGround Balance nxa uthe waguquguqula inkinobho yeCoil/Rx.

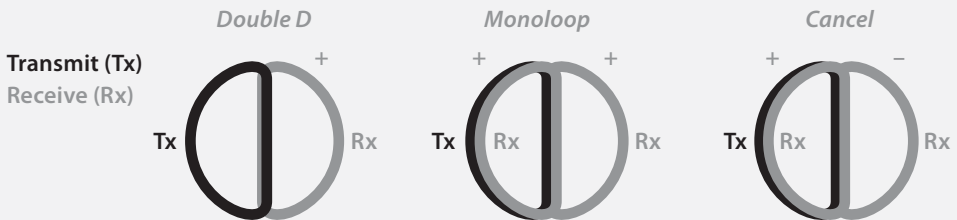

Imidwebo le yingaphakathi yamakhoyili, atshengisa indlela ezintathu amakhoyili anganuka ngazo umhlabathi kusiya ngokuthi inkinobho yeCoil/Rx uyiqondise ngaphi



Isixwayiso: I Iron Reject kayisebenzi nxa usebenzisa ikhoyili yohlobo lwe Monoloop.

I Iron Reject ikhupha imiphumela emihle nxa isetshenziswe ndawonye lamakhoyili ohlobo lweCommander Double D.



IDouble D

Le inhle kakhulu endaweni ezilamatshe aligugu aphakathi laphakathi kusiya kwamanengi kakhulu. Isebenza kuhle ekukhombeni khona kanye lapho okulelitshe khona, njengoba isitshenggiselo selitshe siqine kakhulu enkabeni yekhoyili.

Indlela yokudinga yeDouble D yimbenge esekucineni kumbe inkaba yayo.



IMono

Le ungayisebenzisa endaweni ezilamatshe aligugu amalutshwana kumbe aphakathi laphakathi. UMono ufanele ukusetshenziswa ekudingeni okuzindibilitshi okuncane nxa iSoil/Timings itshunwe yafakwa kuSensitive Extra kuMenyu yeLCD.

Ukusebenzisa ikhoyili yohlobo lweDouble D itshunelwe kuMono kwandise ukwengeza ubukhali bomtshina kodwa kungawenza unghahliseki emhlabathini olamatshe aligugu amanengi. Indlela yokukhomba (ikhasi 77) kakukho enkabeni yekhoyili kodwa kusekuyeni esandleni senxele njalo kungapha isitshenggiselo esikhulu nxa ilitshe liseduze kakhulu lekhoyili. Kuyakhuthazwa ukuthe usebenzise uhlangothi lwakwesenxele ukukhomba amatshe aseduze kakhulu.

Icebo: Amakhoyili ohlobo lweMonoloopangasetshenziswa emitshineni yeGPX akuphe imiphumela emihle kakhulu. Ukuze umtshina uhlaliseke kakhulu sikhuthaza isetshenziswe inkinobho yeCoil/Rx itshunelwe kuMono.



ICancel

Le ipha umkhandlo okwamukela ohlalisekileyo ezindaweni lapho umtshina ophanjaniswa khona zintambo zamagetsi. Ukutshunela kuCancel kuqondile nxa uzingela duze ledolobho kumbe lapho inkinobho yeTune eyehgluleka khona ukuthola umkhandlo othuleyo wokusebenza (njengeduze kwentambo zamagetsi, imithangasla yamamafoni kumbe nxa umumo womkhathi umubi).

Ukukhombamba nxa umtshina utshunelwe kuCancel kswenzeka ngakwesenxele kwekhoyili njalo izitshenggiselo zingabankulu nxa ilitshe liduze kwekhoyili. Nxa kukuCancel, ubukhali lokujula komtshina kuyehla. Ungenelisa iRx Gain (ikhasi 63) nxa usebenzisa uCancel.



Umtshina ngeke ubambe lutho nxa uCancel esetshenziswa lekhoyili yohlobo lweMonoloop.

Ground Balance

Ukumelana lobunengi bamatshe aligugu emhlabathini.

GPX 5000 Range

GPX 4800 Range

Tracking, Fixed

Tracking, Fixed

Tracking



Fixed

Ground Balance

Imihlabathi eminengi ayilatshebetshebe nje kuphela kodwa ilamatshe amanengi aligugu, imithi lamasawudo athize, Lezizinto ezingasimatshe aligugu oqobo zibizwa ngokuthi yibunengi bamatshe aligugu emhlabathini (ground mineralisation). Nxa umtshina ungasatshunwanga ukuthi umelane lakho lokhu kungenza imisinjwana engaqedakaliyo eyaziwa ngokuthi yimisindo yemhlabathi (ground noise). Imisindo yomhlabathi le ingenza kubenzima kakhulu ukuzwa izitshengiselo zamatshe (target response), ikakhulu izitshengiselo ezibuthakathaka ezivela ematsheni akhatshana.

Inkinobho yeGround Balance (GB) esemtshineni wakho weGPX iyezwa umumo wamatshe unjani emhlabathini ube usumelana lawo, wehlise umsindo womhlabathi. Lokhu kwenza ukuthi izitshengiselop zamatshe eqiniso anjengegolide zingafani lomsind lommhlabathi. Umtshina weGPX5000 loweGPX4800 ingasetshenziswa iGround Balance itshunelwe kuTracking lakuFixed.

Tracking



Fixed

Ground Balance

Tracking

ITracking itshela umtshina wesule inhlupho zobunengi bamatshe angalamsebenzi, njalo ihle iqaphele yodwa umumo wamatshe emhlabathini ukuze itshune iGround Balance yodwa nxa kuthe kwaba lenguquko ethize ematsheni amanga la asemhlabathini.

ITracking yandise ukusetshenziswa emihlabathini elamatshe ayimhlobohlobo eminengi, ikakhulu lapho ehlukeno khona kakhulu, kumbe ufuna uhle uhlohlolisa indawo enkulu masinya.

Icebo: Sebenzisa amaGB alula nxa umtshina ukuTracking (ikhasi 41) lanxa ukuFixed (ikhasi 43) ukuze uhlale uhlola ukuthi umtshina wakho uyamelana lomsindo womhlabathi.



IFixed

Le yiGround Balance yokucina. Emhlabathini lapho umumo wamatshe ongaguquki khona, iFixed ipha ukujula, ubukhali lezitshengiselo ezicacileyo; nxa kuyikuthi kwala ufake iGround Balance esebenza kuhle.

IFixed ingasebenza ngcono kodwa idinga wale usenza iGround Balance (ikhasi 42) nxa kudingeka. Ukusebenzisa inkinobho yeQuick Track yindlela elula yokwenza lokhu.

Qaphela: Nxa kusenxa hlala izingela umtshina utshunelwe kuFixed GB ukuze wengeze ukujula lobukhali; usebenzisa uTracking endaweni ezilomsindo womhlabathi omnengi kakhulu kumbe eziguquka umumo wamatshe ngesiphangiphangi, owande ukubizwa ngokuthi ngumhlabathi onhlobonhlobo.

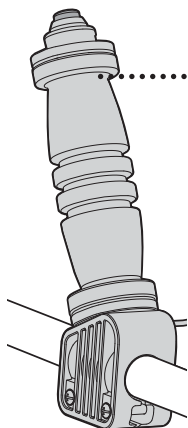

Inkinobho yeQuick Track

Inkinobho yeQuick Track etholakala esibambeni somtshina iyakuvumela ukuthi weqe uye kuFixed kumbe kuTracking.

Inkinobho yeQuick Track iguqula iGround Balance kuphela (Fixed kumbe Tracking) nxa uyifitizela. Ungvele uyekele inkinobho umtshina uhle ubuyele kuGround Balance etshunwe eluhlwini lwamankinobho aphambi komtshina (Front Control Panel).

Inkinobho yeQuick Track yandise ukusetshenziswa ukupha umtshina iGround Balance, kanye lokutshuna iGround Balance ngapha ukhomba lapho okulelitshe khona.

Indlela yokutshuna iGround Balance ukuthi iye kuTracking

Ngemhlobo we-Ground Balance.



- 1 Dinga indawo engelamatshe.
- 2 Tshunela inkinobho yeGround Balance kuFixed.
- 3 Yenza ikhoyili iqondane lomhlabathi, ngapha uphjakaqmise uphinde wehlise ikhoyili phakathi kwe 25mm le100mm (1" le 4") phezu komhlabathi. Zama ukwehlisa ikhoyili iyefika eduze komhlabathi kodwa ingawuthinti.
- 4 Ulokhe usayihambibambisa ikhoyili, tshunela inkinobho yeGround Balance kuTracking uqhubeke usehlisa ukheza ikhoyili umsindo uze uhlaliseke njalo lomsindo womhlabathi usuthule zwi.

Qaphela: Nxa kulokhe kulesitshengiselo esingafuni kuthula ngalesisikhathi kutsho ukuthi kungaba lelitshe leqiniso emhlabathini. Nxa lokhu kungenzeka hambisa ikhoyili kweyinye indawo ube usuphinda lokho okwenzileyo.

- 5 Nxa kungaselanguquko kuThreshold kutsho ukuthi umtshina usuGround Balanced, usungaqala ukuzingela.

Qaphela: Nxa utshintsha inkinobho yeGround Balance uyisusa kuFixed uyisa kuTracking kuba leAuto Ground Balance ehamba ngesiqubu esikhulu anduba umtshina ubuyele esiqubini sokudinga esilungileyo. IGround Balance le egijima kakhulu ibakhona okwesikhatshana nje, kungakho kuqakathekile ukuthi ube uhambahambisa ikhoyili ungakantshintshi inkinobho.



Qaphela: *Sebenzisa indlela le ngemva kwezibanga ezithile ukuze ubone ukuthi uyenelisa yini ukumelana lomsindo womhlabathi.*

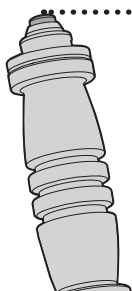

UKUTSHUNA KUTSHA I GROUND BALANCE UMTSHINA UKUTRACKING

Nxa uzingela umtshina ukutracking kumele ngezikhathi ezithize ube ukhangela ukba usadlelana kuhle lomhlabathi yini ngokuma, ube usuphakamisa ubuye wehlise ikhoyile. Nxa inkinobho ingala ilokhu ihlalisekile kutsho ukuthi ulokhu uleground balance. Nxa kungaba lenguquko ethile kuthreshold kutsho ukuba sokumele utshune kutsha i ground balance. Yenza lokhu ngokuqhubeka usehlisa ikhoyili, kumbe uphinde esikhuluma ngakho kukhasi 40.

Ngapha uphakamisa usehlisa ikhoyili fithizela uyekele inkinobho ye Quick-Trak. Uzakuzwa okungumsinjwana okufitshanw okukwazisa ukuthi iauto-Ground Blance egijimayo eyemizwana emithathu isiqalisile ungakabuyeli kuTrackng. Umsindo ungavele uhlaliseke qhubeka uzingela. Nxa ungabona ukuthi iGround Balance isifuna ukube ilokhu itshunwa kutsha, ungakhetha isiqubu se Faster Tracking. Imenyu eku LCD ileziqubu zeTracking ezintathu ongakhetha kuzo (p70).

Qaphela: *Ezindaweni ezilemihlabathi eyinhlobonhlobo kakhulu iTracking ayingeke ihle ilungise iGB khonokhonokho nje nxa uzingela emhlabathini oququla kakhulu amatshe, kungakho kungaba lesikhatshana ungabezwa izitshengiselo zamatshe. Ukuze ungakhuthi izitshengiselo ezizwakalela phansi, kungadingeka ukuthi utshune kutsha i Ground Balance wehlise isiqubu sakho sokuzingela ukuze uvamele i Tracking ukuthi imelane lenguquako esemhlabathini.*



Ngesikhathi lapho iTracking itshuna i Ground Balance, ukuhambahambisaumtshina phezu kwensimbi kungenza umtshina uhambelane lensimbi leyo kulokuthi uhambelane lomhlabathi, okwenza ukuthi ucitshe isitshengiselo esiyiso ukhwele umsindo wemhlabathi. Kungakho kuqakathekile ukuthi usebenzise uFixed nxa ukhomba kumbe nxa uzama ukubamba isitshengiselo esizwakalela phansi kakhulu ngokuhambahambisa umtshina endaweni leyo.

42 Indlela yokutshuna iGround Balance kuFixed

Ngemhlobo we-Ground Balance.



- 1 Dinga indawo engela ngitsho amatshe.
- 2 Tshunela inkinobho yeGround Balance kuFixed.
- 3 Yenza ikhoyili ilinganisane lomhlabathi bese uphakamisa wehlise ikhoyili ngesibanga esiphakathi kwe25mm le 100mm (1" le 4") phezu komhabathi. Zama ukuthi usondeze ikhoyili duze kodwa ingawuthinti.
- 4 Ulokhu usayihambahambisa ikhoyili fithizela ubambe inkinobho yeQuick-Trak. ITracking izaqalisa iGround Balance yesiqubu esikhulu okwesikhatshana nje.

Qaphela: Lokhu kuyafana lokutshunela inkinobho ye Ground Balance kuTracking eluhlwini lwamankibho aphambi komtshina.

- 5 Qhubeka uphakamisa uphinde wehlise ikhoyili umsindo womhlabathi uze ume. Nxa kungasela nguquko eyenzekayo kuThreshold umtshina usuGround Balance.

Qaphela: uma kulokhu kuphindela ukuba le Signal, kungabe kusitsho ukuthi kule Target emhlabathini. Uma kwenzakele, hanbisa iKhoyili kwenye indawo entsha, uphinde njalo.

- 6 Kulula iQuick-Trak button ukuze ubuyele ku-Fixed position, uyephambili ngedetecting.



Qaphela: *Sebenzisa indlela le ngemva kwezibanga ezithize ukuze ubone ukuthi uyanelisa yini ukumelana lomsindo.*

Ground Balance reset in Fixed

Ukutshunwa kweGround Balance umtshina ukuFixed. Nxa uzingela, kumele ngezikhathi ezithize ubone ukuthi usamdana kuhle yini lomsindo wemhlabathi, mana, uphakamise wehlise ikhoyili usendaweni yinye. Nxa iThreshold ingayala ihlalisekile kutsho ukuthi ulokhu uGround Balanced. Nxa kungabe lenguquko ethize kuThreshold kutsho ukuthi sekumele utshune kutsha iGround Balance.

Lokhu ungakwenza ngokuphinda izigaba 3 – 6 kundlela yokutshuna iGround Balance (uzingela ikuFixed) ekukhasi 42.



Amacebo okwenza iGround Balancing

Nxa uhamba ezigabeni ezindala (indawo ezincane ezinothileyo ezaziwayo ukuthi zike zaba legolide) hambisa iGround Balance ikuFixed ubuye ube ulokhu uyitshuna kutsha iGround Balance usebenzisa inkinobho yeQuick – Trak ngemva kwezibanga ezimbalwa nje.

Nxa usenza iGround Balancing endaweni elamadwala amanengi yehlisa ikhoyili isondele phezu komhlabathi.

Emihlabathi emagnetic ungaba lobunzima ekhuthini wehlise ikhoyili ize iyefika duze komhlabathi (ikakhulu nxa usebenzisa amakhoyili amakhulu ohlobo lweMonoloop). Nxa kungenzeka lokhu, ungaguqula iGround Balance Tyre iye kuSpecific, edinga indlela yokwenza iGround Balance eyehlukileyo (p56).

Ungananzelela ukuthi umhlabathi lowo ufuna ube ulokhu utshuna kuhle umtshina ungakhetha ukudinga ukuTracking.

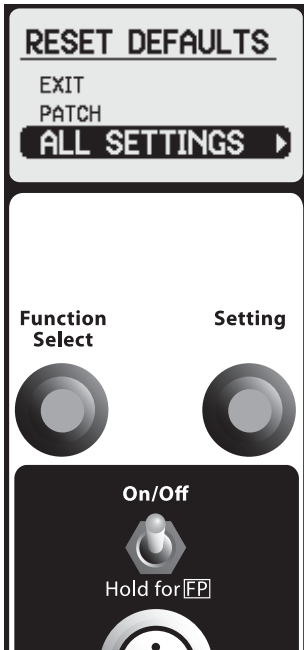

Imitshina ye GPX ibuya ilendawo yeFactory Preset [FP]  kumenyu efanele labo abaqala ukusebenzisa imitshina le.

Uze ube wazi umtshina wakho ungawusebenzisa nje usebenzisa amaFactory Presets le Front Control Panel.

KuGPX 5000 Qaphela lokhu: Nxa usenza iAll Settings reset ukutshuna okwenze kuma Custom Search Modes womane kuyagcinwa. Lokhu kwenzelwa ukuthi ukutshuna kwakho kungaze kwalaweka ngengozi kodwa ngapha uvumela imenyu ekuLCD, Deep Mode leGeneral Mode ukuthi zibuyele ekutshunweni ezathengwa zikukho.

Ukubuyisela konke kuFactory Preset:

- 1 Citsha umtshina.
- 2 Fithizela inkinobho ye On/Off uyale uyifithizele kuze kuvele imenyu ye Resets Defaults (okwemizuzwana engu5 – 6).
- 3 Tshunela inkinobho yeFunction Select kwesokudla ukuze ukhethe u All Settings (njengalokhu okubona emudwebeni).
- 4 Tshunela inkinobho yeSetting kwesonxele kumbe kwesokudla ukuze ubuyisele ku Factory Presets. Umtshina uzabuyisela konke kuFactory Presets ube sucitsha uphinde layithe kutsha wodwa.

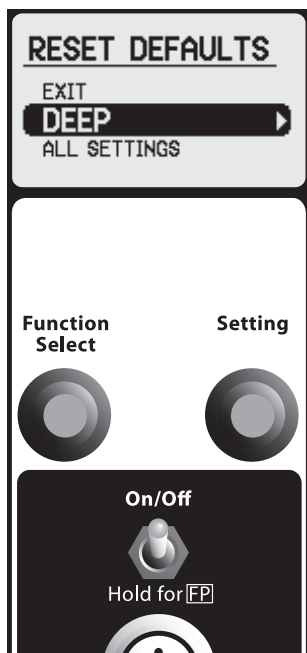

Ukubuyisela kuFactory Preset usebenzisa iSearch Mode eyisebenzisayo:

KuGPX5000 Qaphela lokhu: Nxa ufuna ukuqalisa kutsha ukutshuna iCustom Search Mode hoba leqiniso lokuthi uyikhethile kumenyu ungakawucitsi umtshina wakho.

- 1 Citsha umtshina.
- 2 KuControl Panel yaphambili. Faka i Search Mode kuleyo ofuna ukuyibuyisela kuFactory Presets.
- 3 Fithizela inkinobho ye On/Off uyale uyifithizele kuze kuvele imenyu yeReset Default (okwemizuzwana engu 5-6).
- 4 Tshunela inkinobho ye Select Function kwesokudla ukeze ukhethe isearch mode.

Qaphela: Nxa iSearch Mode eveziweyo ingayisiyo oyifunayo ukuyibuyisela kumele untshintshe i Search Mode kunkinobho ye Front Control Panel.

- 5 Tshunela inkinobho ye Setting kwensenzele kumbe kwesokudla ukuze ubuyisele kuFactory Preset. Umtshina uzabuyisela ku Factory Preset ube sucitsha uphinde ulayithe kutsha wodwa.

GPX 4800 Main Menu (Universal Functions)

Function	Range	Factory Preset
Backlight	Off, 1–8	2
Battery Test	0–8.0V, +8.0V	–
Volume Limit	1–20	12
GB Type	General, Off	General
Special (Soil/Timings)	Sens Extra, Sharp, Coin/Relic, Salt-Coarse	Sens Extra
Manual Tune	0–255	128



Icebo: Kuze kube yisikhathi lapho osukwazi khona ukusebenzisa imitshina ye GPX 5000 kumbe iGPX 4800, imitshina le ingasebenziseka isebenzisa amaFactory Presets le Front Control Panel (p24).

GPX 4800 Search Mode Menu (Mode Specific Functions)

Function	Range	General	Deep	Hi-Mineral
Motion	Very Slow, Slow, Medium	Slow	Very Slow	Medium
Rx Gain	1–15	8	9	6
Audio Type	Quiet, Normal, Deep	Normal	Deep	Normal
Audio Tone	1–100	50	38	45
Stabilizer	1–10	5	5	4
Signal Peak	1–20	16	17	14
Target Volume	1–20	8	8	7
Tracking Speed	Slow, Medium, Fast	Medium	Slow	Fast
Iron Reject	Off, 1–10	Off	Off	Off

<i>GPX 5000 Main Menu (Universal Functions)</i>		
<i>Function</i>	<i>Range</i>	<i>Factory Preset</i>
Backlight	Off, 1–8	2
Battery Test	0–8.0V, +8.0V	–
Volume Limit	1–20	12
GB Type	General, Specific, Off	General
Special (Soil/Timings)	Sens Smooth, Fine Gold, Sens Extra, Salt/Gold, Sharp, Coin/Relic	Fine Gold
Manual Tune	0–255	128

<i>GPX 5000 Search Mode Menu (Mode Specific Functions)</i>							
<i>Function</i>	<i>Range</i>	<i>General</i>	<i>Deep</i>	<i>Patch</i>	<i>Hi-Mineral</i>	<i>Hi-Trash</i>	<i>Pinpoint</i>
Motion	Very Slow, Slow, Medium, Fast	Slow	Very Slow	Medium	Medium	Medium	Very Slow
Rx Gain	1–20	11	12	8	8	12	15
Audio Type	Quiet, Normal, Deep, Boost	Normal	Deep	Boost	Normal	Quiet	Boost
Audio Tone	1–100	50	38	55	45	40	50
Stabilizer	1–20	10	10	8	9	8	8
Signal Peak	1–20	16	17	15	14	8	18
Target Volume	1–20	8	8	9	7	6	13
Response	Normal, Inverted	Normal	Inverted	Normal	Normal	Inverted	Normal
Tracking Speed	Slow, Medium, Fast	Medium	Slow	Medium	Fast	Slow	Slow
Iron Reject	Off, 1–10	Off	Off	Off	Off	7	Off

48 Inkinobho ye Function Control ukuScroller ngama-functions.

Title.....
Itshengisa ukuthi yiwuphi umsebenzi owubhekileyo (oweuniversal kumbe imode).

Functions (Imisebenzi).....
Kulemihlobo emibili yama functions, kule universal function engaphansi, kwesihloko so Main Menu le Mode Specific functions (engaphansi kwesihloko se Search Mode).

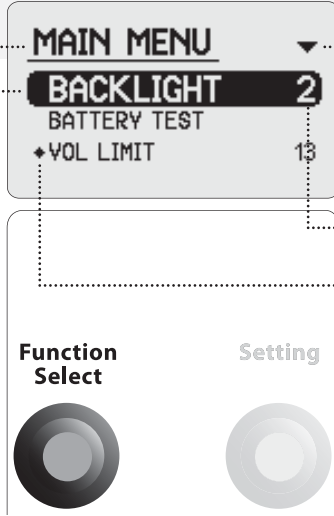

Navigation Arrows
Atshengisa ukuthi imeny ihamba isiya ngaphi.

Function Setting

New Value Icon
Itshengisa ukuthi ifunction le isiguqulwe isuka ku Factory Preset yafakwa ngaphi.

Ukulamba phakathi kwemenyu yeLCD:

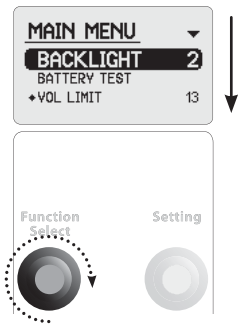

Tshuna inkinobho ye Function Select iye kwasokudla ukuze ihambe ikhethe isiyaphansi. IFunction eyabe ikhethwe ngaleso sikhathi iyabe iconjiwe.

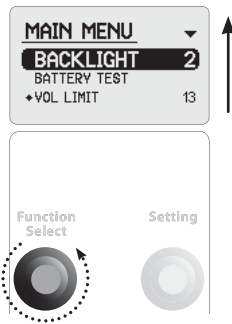

Tshunela inkinobho ye Function Select kwesenxele ukuze ihambe ikhethe isiyapheza ifunction eyabe ikhethwe sikhathi iyabe iconjiwe.

Inkinobho yesetting

Ukutshuna kuhle.

Ungavela ukhethhe ifunction ethize, inkinobho yesetting ihle ivule lapho ongatshuna khona eglazini.

Function

Function Setting

(Visual Scale)

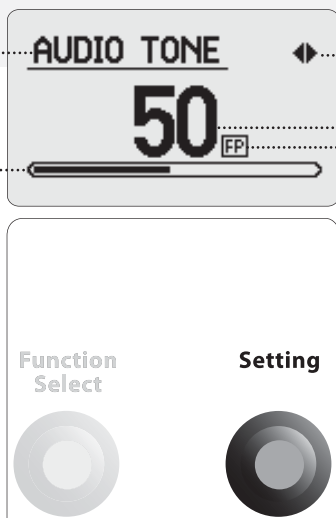

Navigation Arrows

Atshengisa lapho ongaguqula usiya khona.

Function Setting

(Izinombolo)

Factory Preset Indication (FP)

Itshengisa ukuthi umtshina usebenza ulapho owangiswa watshiywa khona ku Factory Preset.

Ukutshuna iFunction:

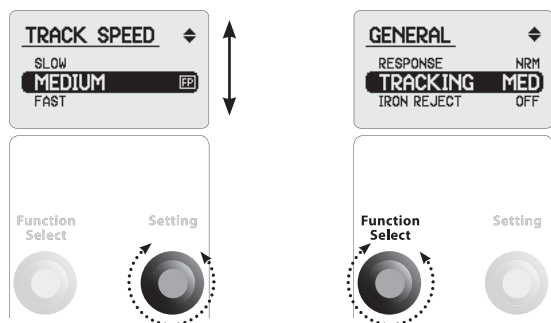

Nxa kule function econjiweyo tshibilikisela inkinobho yeSetting swesenzele kumbe kwesokudla ukuze utshune.

Ukuze ubuyele eluhlwini lwama functions eluhlwini lwamafunctions tshibilikisela inkinobho yeFunction Select kwesenzele kumbe kwesokudla.



Qaphela: inguquko ongazenza kuFunction zihle zigcinwe. New Value Icon ihle ivele kuMain Menu nxa iFunction ingaguqulwa (bona ikhasi 48).

Ilayithi leglazi langemuva kweLCD

GPX 5000 Range	Off, 1–8
GPX 4800 Range	Off, 1–8
Factory Preset	2



Ezindaweni ezingakhanyi kuhle iLCD ingalayithwa ngemuva. Ungakhetha ukuthi ufuna ilayithi lelo lihlale isikhathi eside kanganani lilayithile. Phakathi kuka 1 lo 6 isikhathi sokucitsha kwelayithi leli sengezigaba zemizuzwana elitshumi.

1 – 10 seconds

2 – 20 seconds



6 – 60 seconds

7 – 120 seconds

8 – lihlala liyithile

Isikhathi lesi sitsho imizuzwana ezathathwa lilayithi lelo lilayithi lelo lulayithile kusukela ngesikhathi oyabe utshune ngaso inkinobho yeFunction Select kumbe eye Setting.

Ilayithi lizalayitha njalo nxa ungabamba nje eyinye inkinobho.

Nxa uzingela emini ungakhetha uOF ukuze ulondolozwe umlilo webhatiri.

Ukuhlola ibattery

Ukubona ukuthi ibattery lilomlilo ongakanani.



Example Screenshot

Iglazi elitshengisa ibattery test likuvumela ukuthi ubone ukuthi umlilo osebhatirini ungakanani.

Nxa umlilo usuphansi uzakuzwa okuyimisinjwana okulandelanayo ngomzuzu ngomzuzu.

Qaphela: Iglazi lebattery test lihle libuyele lodwa kuma functions ngemva kwemizuzwana eyisikhombisa.

Ukuze uthole okunengi mayelana battery lemitshina ye GPX bona isihlobo esithi Charging (kumakhasi 18-19) lesithi Asithi ukunakakela ibattery lakho (kukhasi 21).

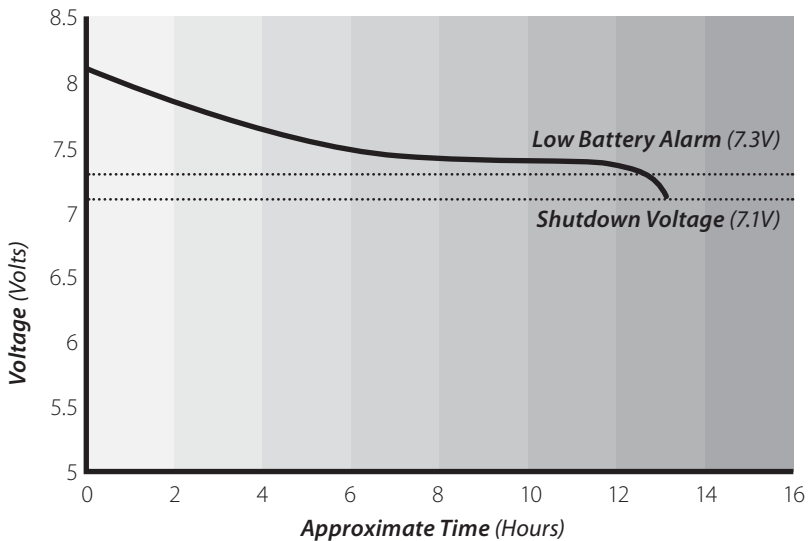

Amabathiri ohlobo lwe Lithium-ion ayagcina umlilo, kawamane acithe nje.

Volume Limit

Ukukhweza i Volume.

GPX 5000 Range	1–20
GPX 4800 Range	1–20
Factory Preset	12



IVolume Limit ifakwa ekucineni umsindo ongakhutshwa ngumtshina nxa usuthe wabamba ilitshe.

Nxa iVolume Limit ifakwe ekucineni, izitshengiselo zamatshe zonke zizakwala, njalo umsindo wakhona uzahambelana lobukhulu kanye lokujula kwalokho okubanjweyo. Ivolumu esekuncineni yenza uzwe umahluko phakathi kwelitshe elincane lelikhulu, kodwa ingababuhlungu ezindlebeni zkho nxa uthe wabamba ilitshe eduzane lekhoyili.

Nxa iVolume Limit ifakwe phakathi laphakathi, umsindo wesitshengiselo esincane kawantshintshi kodwa owesikhulu uyehla kancane.

Nxa iVolume Limit ifakwe kakhulu umsindo wezitshengiselo ezinengi uzabe wehlile. Ivolumu ephansi kayibuhlungu endlebeni kodwa ingezelela amathuba okuthi ukuthe izitshengiselo ezincane.

Zama ukusebenzisa ilitshe elincane lelikhulu ukuthi utshune iVolume Limit yakho uye endaweni oyifunayo.

Qaphela: IThreshold ingafuna ukutshunwa kutsha nxa uthe wehlisa iVolume Limit yayaphansi.



Isixwayiso: Umtshina ulakho ukukhipha umsindo omkhulu kakhulu nxa uthe wabamba ilitshe elikhulu kumbe elingajidanga kakhulu.

Vikela izindlebe zakho!

IVolume Limit ingafuna ukutshunwa kutsha nxa ungantshintsha izipikha usuka kwezendlelene usiya kwesikhulu esaphandle.

**Maximum Volume Limit:
(IVolume ekhwezwe yaphelela)**

Izitshengiselo ezincane lezinkulu kazintshintshi.

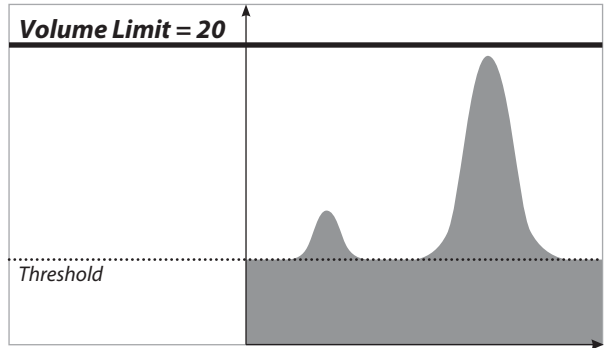

**Mid-Range Volume Limit:
(Ephakathi laphakathi)**

Izitshengiselo ezincane kezintshintshi kodwa ezinkulu ziyehliswa umsindo wazo.

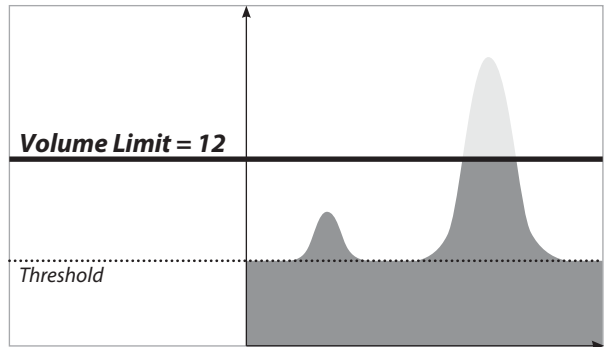

**Minimum Volume Limit:
(Ephansi)**

Zonke izitshengiselo ezincane lezinkulu ziyehliswa umsindo wazo.

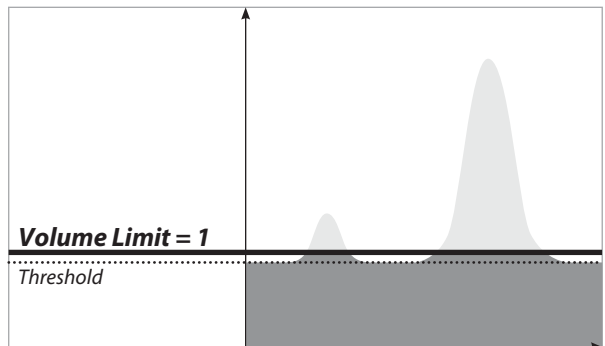

54 | Ground Balance Type

GPX 5000 Range
GPX 4800 Range
Factory Preset

General, Specific, Off
General, Off
General

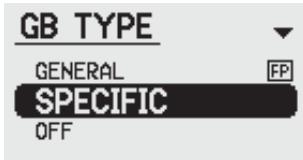
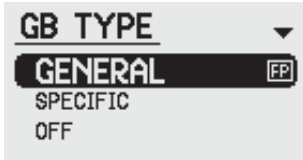

IGeneral

Le yiyo iGround Balance Type engcono kakhulu ukuyisebenzisa emihlabathini elegolide engaphezu kwengamashumi ayisitshiyagalolunye ekhulwini, njalo isebenzisa iTracking ezitshuna yodwa njengaleyo etholakala emitshineni yeMinelab emidala. Nxa ukuTracking, iGeneral Ground Balance (GB) iyakhangelwa umumo wamatshe asemhlabathini ibe isitshuna iGround Balance ehamba intshintshantshintsha yodwa ukuze imelane lomumo yomhlabathi. IGeneral GB yiyo kanye eyokesebenzisa emihlabathini elamatshe aligugu amanengi njalo yiyo iGround Balance Tyre ethanda ukusetshenziswa emihlabathini elamatshe atshiyetshineyo.

ISpecific (GPX 5000)

Le yiGround Balance Tyre eyenzelwa ukusebenza emihlabathini emagnetic lele ayoni enengi. Ukusebenzisa iSpecific GB kuzakwenza usondeze ikhoyili duze komhlabathi, njalo yenza amakhoyili ohlobo lweMonoloop abe Ground Balanced kuhle ezindaweni ezitsha okokuthi angasebenzi kahle. Inkinobho yeTracking isebenza kuhle lespecific kula nxa ile General njalo kayisoze ikhuthe loba isitshengise sincane kangakanani, okwenza kungabi lengozi yokukhutha amatshe.

Kuyakuthazwa ukuthi uhlale uhlola iGB yakho nxa usebenzisa uSpecific emihlabathini eyinhlobonhlobo. Uma ngezikhathi ezithize uphakamise wehlise ikhoyili, ulale ukuze uzwe nxa kungabe sekukhona osekuntshintshile, yenza njalo iGround Balance nxa kudingeka kahle kahle, iSpecific GB kumele isetshenziswe kuphela emihlabathini efanayo engelanhlobo nhlobo zamatshe.

Qaphela: IGround Balance Procedure eyehlukeneyo iyadingakala nxa usebenzisa iGround Balance Type Specific. Bona isihloko esithi **Ground Balance Procedure for Specific**, ikhasi, 56, ukuze uthole okunengi.

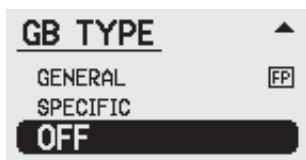

(Ground Balance) **Off**

Emihlabathini ethuleyo enjengaleyo engelamatshe aligugu kumbe elitshebetshebe, kungangabikhona uhlupho lomhlabathi. Indawo ezinye zinlutshwana kodwa zibonakala ngokungenzi lutho kwe **Ground Balance** yakho. Ngokufaka iGround Balance Type yakho ku**OFF** ungathola ukujula lobukhali obungcono.

Lokhu kwandise ukusetshenziswa ngabazingela etshebetshebeni elingaphandle kolwandle kumbe abadinga indibilitshi eganeni, njengoba kukalutshwana kakhulu ukuthi uthole indawo engafuni i**Ground Balance**.

IProcedure (Itshunwa njani):

Phakamisa ikhoyili uyisuse emhlabathini, khatshana lezinsimbi ube sufaka inkinobho ye **GB** ku**Off**. Nxa ungezwa umsinjwana usungaqalisa ukuzingela.

Qaphela: Inkinobho ye Iron Reject (Ikhasi 74) ipha impumela emihle kakhulu nxa usebenzisa i GB Tyre General.

Indlela yokufaka iGround Balance ku Specific

Nxausiya endaweni entsha iSpecific Ground Balance yakuqala kumele yenziwe ngenkinobho ye Ground Balance hatshi inkinobho ye Quick – Trak.

- 1 Dinga indawo emhlabathi engela ngitsho amatshe.
- 2 Khetha uGB Type Specific ku Menu.
- 3 Ququlela inkinobo ye Ground Balance ku Fixed.
- 4 Bamba ikhoyili iku 300 – 450mm (12" – 18") phezu komhlabathi.
- 5 Faka inkinobho ye Ground Balance ku Tracking. Uzezwa okungumsinjwana okuphezulu okuzathatha umzuzwana nje.

- 6 Nxa umsinjwana ongumdumo ophansi ungaqalisa uhle uqalise ukukhwenza usehlisa ikhoyili phezu komhlabathi. Uzame ukwehlisa ikhoyili ilingisane lomhlabathi njalo iseduze kwawo kodwa ingawuathintanga.

Qhubeka ukhweza usehlisa ikhoyili umdumo lowo uze uhlaliseke njalo lomsindo womhlabathi uze uthule. Nxa kungasenguquko ebakhona ku Threshold kutsho ukuthi umtshina usu Ground Balanced.

- 7 Buyesela iGround Balance ku Fixed, uqalise ukuzingela.

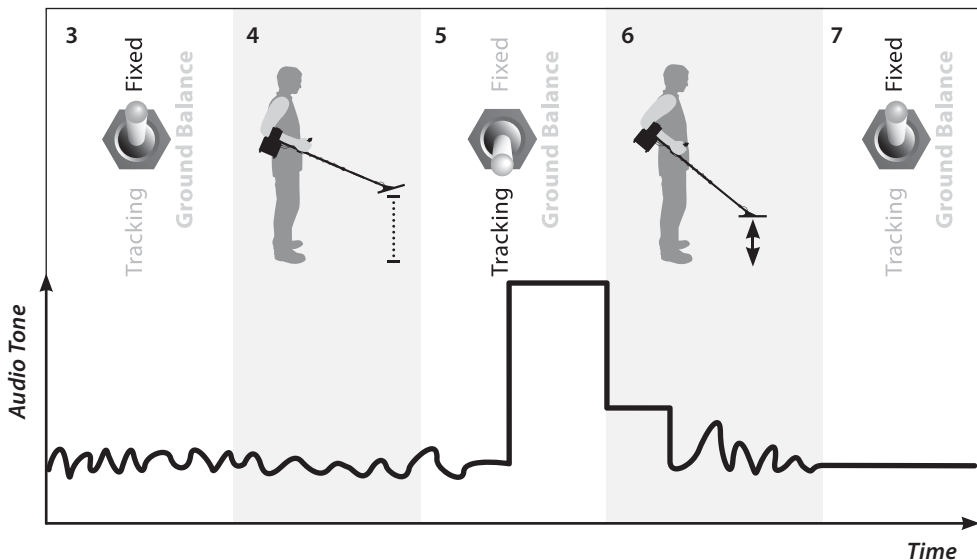

Special Soil/Timings

GPX 5000 Range
GPX 4800 Range
Factory Preset

Sens Smooth, Fine Gold, Sens Extra, Salt/Gold, Sharp, Coin/Relic
Sens Extra, Sharp, Coin/Relic, Salt-Coarse
Fine Gold (GPX 5000), Sens Extra (GPX 4800)



Ungakhetha ukuthi ufuna kesebenze wapho amatimings usebenzisa inkinobho ye Special Sensitive Smooth (GPX 5000).



ISensitive Smooth (GPX 5000)

ISensitive smooth isebenza kuhle ekubambeni izitshengiselo zamatshe amancane, angajulanga kakhulu emihlabathini elamatshe amanengi. Kungalahleka okwesikhatsha ukulujia ematsheni amakhulu, kungakho ungayisebenzise le nxa udinga amatshe amakhulu lajulileyo.

***Qaphela:** ISensitive Smooth isebenza kuhle lamakhoyili ohlobo lwe monoloop emihlabathi esembenzeka nzima.*

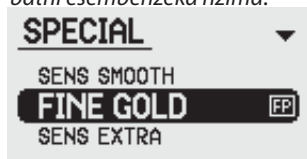

ISensitive smooth iyavuma ukusebenza lamakhoyili ohlobo lwe monoloop ezindaweni ezilamatshe amanengi. Ikipha izitshengiselo zamanga ezisuka emandwaleni atshisayo kumbe emihlabathini o lamatshe lesawudo elinengi, ngapha ilondoza ubukhali obukhulu ekubambeni amatshe amancane.



IFine Gold (GPX 5000)

UFine ubukhali kakhulu ematsheni amancane emihlabathini elesawudo lemithi eminengi. Ipha isitshhengiselo esicacileyo nxa kulegolide elincane nxa iqathaniswa lo enhance njalo yenza igolide elingacolenga libambeke ngcono, ngasikhathi sinye itshaya indiva amadwala atshisayo amanengi lezitshhengiselo zamanga. Umhlabathi ongatshoniyo olamatshe aligugu amanengi owake wakhupa igolide, kumele uhlolwe kutsha usebenzisa uFine Gold, njalo ungathola impumela emihle ngokuenzisa amakhoyili ohlobo lweMonoloop Commander awe 11" le 18".



ISensitive Extra

ITiming le yengeza izitshhengiselo ezivela kwamanye amadwala atshisayo aseduze laphezu komhlabathi, kudwa ingosiza ukulolonga iThreshold kweminye imihlabathi, ikakhulu lamakhoyili ohlobo lweDouble D. Emihlabathini ephakathi laphakathi iSensitive Extra ipha izitshhengiselo zamatshe amancane ezicacileyo.

ISalt/Gold (GPX 5000)

Le yenzelwe ukusetshenziswa emihlabathini elesawudo elinengi. Kumele isebenze kuhle emhlabathini elesawudo, ensimini zegolidhe ezilesawudo lasematshebetsheni aseceleni kolwandle

GPX 5000 Range
GPX 4800 Range
Factory Preset

Sens Smooth, Fine Gold, Sens Extra, Salt/Gold, Sharp, Coin/Relic
 Sens Extra, Sharp, Coin/Relic, Salt-Coarse
 Fine Gold (GPX 5000), Sens Extra (GPX 4800)



Qaphela: USharp wandiso ukusebenza kuhle lamakhoyili ohlobo lweDD.



olulesawudo elinengi. Imihlabathi elesawudo elinengi kakhulu ifuna ukuzingelwa inkinobho yekhoyili ikuCancel (usebenzisa iKhoyili yohlobo lwe Double D).

Uyaqhutshwa

USharp ufuna lognormal kodwa ukhipha ukuzingela okulamandla kakhulu. Angengeza ukujula kodwa angangenelwa kakhulu ngezinye izinto njalo wenza kube lezitshengiselo zamanga ezinengi emihlabathini esebenzeka nzima. Itiming yeSharp isebenza kuhle kakhulu nxa umumo uthule njalo lanxa ihlanganise le Deep Search Mode le Rx Gain eyehlisiweyo.

ICoin/Relic

Le yenzelwe ukusetshenziswa emihlabathini elula lasetshetshebeni lolwande. Ipha ukujula kokuzingela okuphezulu kakhulu kumihlobo etshiyeneyo yamatshe ukwedlula amanye amaTiming. Kodwa, nxa umhlabathi ungavele ube nzima, umtshina ungehluleka ukwenza iground balance. UCoin/Relic usebenza kuhle emapaki, ezindaweni zokuzilibazisa lasemantuwani, kungakho yiyo kanye eyokusenzisa nxa udinga imali, indibilitshi, amangqongqo lokunye nje. Nxa isthebetshebe lolwande liletshebetshebe emnyama ungathola impumela engcono nxa ungasebenzisa uNormal kumbe salt/Gold(GPX5000).



ISalt-Coarse (GPX 4800)

Uhlupo lobumnyu besawudo behlukile kulolo elwamatshe e-ayoni lawodaka. Oseko wasebenza ezindaweni ezilesawudo eliwomileyo uyazi ukuthi kunzima kanjani ukuzingela kuzozama ukuqala ngokusebenzisa uNormal, kodwa nxa iThreshold ingasahlalisekanga kakhulu sebenzisa u Salt-Coarse.

Ukusebenzisa uSalt-Coarse kungenza wehluleka ukubamba izitshengiselo ezincane. Kodwa izitshengiselo zamatshe amakhulu kaziguquki njalo umsind womhlabathi uyehliswa. Kungakho, nxa udinga amatshe ajulileyo amakhulu emihlabathini elamatshe amanengi itiming ye Salt-coarse ingasetshenziswa ukuthola iThreshold elolongekileyo eyenza uzwe izithengiselo lezo ezijulileya.

Manual Tune

Ukwehlisa ukungenela kwamagetsi

GPX 5000 Range

0–255

GPX 4800 Range

0–255

Factory Preset

128

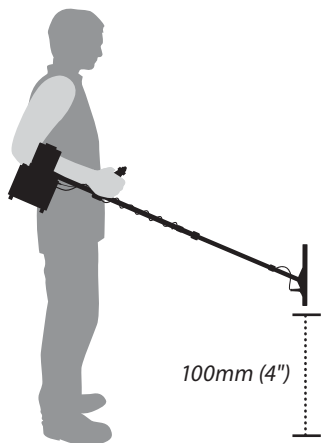

Qaphela: isiqubu seMotion esincane laso siyehlisa ukungahlaliseki okungabangelwa yikungenela.

iManual Tune yenza wenelisa ukudinga ukhethe itshaneli oyifunayo.

Ukwenza iManual Tuning uze uyeqeda kudla izikhathi esinengi. Sikhuthaza ukuthi wenze iManual Tune nxa utshuna izinto ezincane nje usuke wenza iAuto Tune (khasi 32).

Ungathola ukuthi ungenelisa ukukhetha itshaneli ekucineni koluhlu lwawo nxa izingela ezindaweni ezithuleyo kungela kungenela okukhona. Inombolo eziphansi zitsho amatshaneli angabambi kakhulu. Amatshaneli akamba kakhulu angababukhali ekubambeni amatshe amancane. Kuthi lawo abamba kancane aphe ukujula okungcono ematsheni amakhulu. Kodwa umahluko okhona mncane kakhulu.

- 1 Misa ikhoyili ikhangele phezulu okungaba yi 100mm(4") phezu komhlabathi usiba leqiniso lokuthi akulamatshe aligugu amakhulu kumbe ukungenela kwagetsi eduze.
- 2 Ngena kuManual Tune ngoMenu.
- 3 Khweza wehlise inombolo kancane kancane, usima kancane ekuntshintsheni konke okwenzayo.
- 4 Lalela wonke amatshaneli owazwayo uze uzwe elomsindo omncane kakhulu.

Qaphela: Nxa ukungenela kungayala kukhona wena usutshunile, zama ukwehlisa iRx Gain, kodwa ezindaweni lapho okulokungenela okukhulu kungadingeka ukuthi usebenzise uCancel kunkinobho yeCoil/Rx.

Nxa ungatshibilikisa inkobho ugijima uzananzelela umsindo obangelwa yikugijima udlula amatshaneli. Lokhu kuyinjwayelo njalo akubikhona nxa ungayibilikisa kancane kancane.

Ukuguqula ama Search Models (GPX⁵⁰⁰⁰)

Usebenzisa iLCD.

GPX 5000 Range
GPX 4800 Range
Factory Preset

Patch, Hi-Mineral, Hi-Trash, Pinpoint
 Not Available
 Patch



Inkinobho ye search mode, eku Front Control Panel ikupha indlela yokungena amaModes okungela amanengi ongawasebenzisa. UDeep loGeneral zindawo ezimbili ekunkunobho ye Search Mode, eyithathu yiCustom. Ucustom wenza wenelise ukukhetha eyinye yama Mode amane akuLCD.

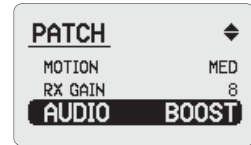

UKukhetha iCustom Search Mode oyifinayo:

- 1 Faka inkinobho ye Search Mode kuCustom.
- 2 Usebenzisa inkinobho yeFunction select, hamba phakathi kwemenyu uze uyefika kuCustom Search Mode uPatch.
- 3 Usebenzisa inkinobho yeSetting dinga iSearch Mode oyifunayo eg. Hi-Mineral.
- 4 Tahibilikisela inkinobho yeFunction Select yiloba kuluphi uhlangothi ukuze ubambe lokho okukhethileyo.
- 5 Usungehla phansi ukuze ubone ukuthi uHi-Mineral utshunatshunwe njani.

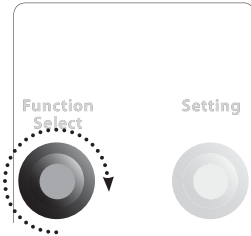

Icebo: Ngokukhetha uPinpoint njenge Custom Search Mode yakho, ngapha uzingela ukuGeneral kumbe uDeep, ungenelisa ukuthi tshampu uye kuCustom ukuze ukhombwe ilitshe.

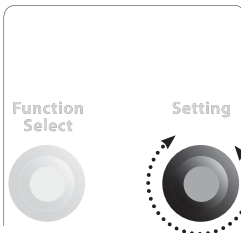



Icebo: Nxa ufuna ukuthi jeqe uqathanisa amaSetting ungaguqula inkinobho ye Search Mode emphambi komtshina iye kuDeep, General leCustom oyikhethileyo, ngasikhathi sinye ubheka amaFunctions avezwa kuLCD.

Ukuguqula ama Search Modes awakhethileyo

Ungabumba amaSearch Modes akho wedwa awokusebenzisa ezindaweni ezitshiyeneyo, ematsheni atshiyeneyo, lamakhoyili obukhulu obutshiyeneyo njalonzalo. AmaFunction wonke avezwa ngaphansi kwegama leSearch Mode ekuLCD Menu ngawayonaleyo Search Mode kuphela kuCustom Search Mode yinye ngayinye.

Khetha iSearch Mode ofuna ukuyiguqula ube sukhetha amaSetting amatsha yiloba kuyiphi iFunction ofuna ukuyiguqula. Inguquko zonke ozenzile zihle ziganwe umtshina ube sucitsha.

Ungetha elinye lamagama alitshumi lane, aselulwini lwe Custom Names List (khasi 76) kweyinye leyinye yamaCustom Search Mode amane.

Motion

Ukuguqula isiqubu sokuhambahambisa ikhoyili phezu kwendawo engaba lelitshe.

GPX 5000 Range

GPX 4800 Range

Factory Preset

Very Slow, Slow, Medium, Fast

Very Slow, Slow, Medium,

Slow



Isiqubu ohambahambisa ngaso ikhoyili siba lokokwenza esikhathini esithathwa lilitshe ukuze liphendule lekuguquleni iGround Balance. Ukuqondanisa isiqubu lesi ukuze sihambane lemotion kungehlisa umsindo womhlabathi lezitshengiselo zamatshe zibe ngano.

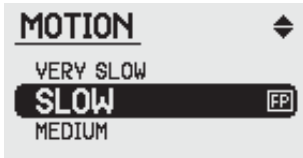

Very Slow and Slow

ISetting yeMotion le ipha iThreshold ehlalisekileyo, eyenza ibe yiyo eyotshenziswa ngabaqalisayo lasekuzingeleni ezindaweni ezinengi. Nxa uzingela ngonanzelelo endaweni emancane, iSlow Motion kuhle, ukuhambahambisa ikhoyili kancane ukekekile kumele ukwenze utshunele ku Slow Motion.

Qaphela: Kuqakathekile ukuthi iMotion oyikhetayo ihambelane lendlela ozulisa ngayo ikhoyili.



IMedium

IMotion le yandise ukusebenza nxa uhambahambisa ikhoyili kahle kahle. Umsindo wangemuva ungakwela kancane nxa kuqathaniswa laku Slow, kungakho ifanele asebejwayele ukusebenzisa umtshina.



IFast (GPX 5000)

IFast Motion isebenzisa kuhle nxa ukuzingela ngokuphangisa ukuze uqede indawo enkulu. Nxa kunje, isitshengiselo asicacileyo esihlabayo sizakwazisa umzingeli nxa kulelitshe phansi UFast wenza wenelise ukuthi uqede indawo enkulu ngesikhathshana.

Qaphela: Isiqubu seMotion silokokwenza okuthi umtshina ungaphanjaniswa njani yizinto ezingenelayo. Nxa isiqubu seMotion sisincane lokungenelwa kuba kulutshwana, okwenza iThreshold ihlaliseke.

Nxa iThreshold ingahlalisekanga usebenzisa uMedium kumbe uFast Motion, ungakhetha u Quite Auto Type (khasi 64) kumbe wehlise iRx Gain (khasi63).

Rx Gain

Ukuguqula ubukhali komtshina.

GPX 5000 Range

1–20

GPX 4800 Range

1–15

Factory Preset

11 (GPX 5000), 8 (GPX 4800)



Umsebenzi weRx Gain yikwenza imitshina yeGPX imelane yiloba lawuphi umumo, inqanda ubukhali bomtshina ukuthi uhambelane lendawo lamatshe atholakala khonapho.

Nxa umtshina utshunelwe kuRx Gain ephezulu uyenelisa ukudobha amatshe amancane latshonileyo kodwa ungasabela lasezintwani ezingafunekiyo ezinjengokungenelwa lomsindo womhlabathi, iRxGain ephezulu iyakhuthazwa emihlabathini ephakathi lapakhathi lasendaweni okungela kungenelwa khona.

Nxa umtshina utshunelwe kuRxGain ephansi ungasabela izinto ezingafunekiyo ezinlutshwana lomsindo omcane, kodwa ungakhutha amatshe ajulileyo. iRxGain encane ingcono ezindaweni ezilomsindo omnengi kumbe ezilokungenelwa okunengi.

Inkinobho yeRxGain kumele itshunwe ukuze ihambelane lomumo womhlabathi kanye lekhothi esetshenziswayo. Njengokuthi nxa usuthole indibilitshe ezithile endaweni njalo ufuna ukuzingela indawo yona leyo ngekhothi enkulu, kungadingeka ukuthi wehlise RxGain.

Uhlale uleqiniso lokuthi umtshina ule Ground Balance eqondileyo, watshunwa, ungakaguquli iRxGain.

Qaphela: Uzimisile ukwehlisa iRxGain nxa iThreshold yangemuva ingalunganga. IThreshold elolongekiyo yiyo elungileyo, njengoba umsindo omnengi uzakwenza ukuthi isitshengiselo esiphansi singazwakali.



Icebo: Zama ukusebenzisa iMotion ephansi (khasi 62) ukuze Icebo ube le Rx Gain ephezulu igeneliseka.

Nxa usebenzisa inkinobho ye khothi/Rx kuCancel (khasi36) iRx Gain bephezulu ingeneliseka.

Audio Type

Ukuguqula umsindo owenziwa yizitshengiselo zamatshe.

GPX 5000 Range

GPX 4800 Range

Factory Preset

Quiet, Normal, Deep, Boost

Quiet, Normal, Deep

Normal



IAudio Type ukuvumela ukuthi uguqule indlela umtshina ochasisa ngayo isitshengiselo selitshe lokuthi isitshengiso lesa siphuma nja singumsindo.

IQuiet

Le yehlisa kakhulu umsindo womhlabathi lokungenelwa. Isitshengiso siza sithule kancane nxa kuqathaniswa lamanye amaAudio Types. uQuite kumele asetshenziswe ezindaweni ezinzima kakhulu kuphela.

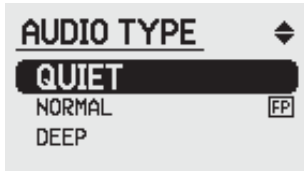

INormal

Le yiyo esebenzisa kalula njalo kumele isetshenzi nxa umuntu ezingela umumo ulungile. Ipha ubudlelwano obuhle kakhulu phakathi kwesitshengise lokuhlaliseka.

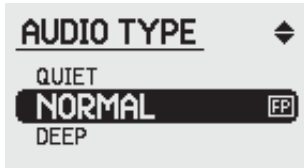

IDeep

Le yiyo iAudio Type ethandwayo nxa udinga amtshe amakhulu ajulileyo. Isebenza kuhle nxa ile Slow Motion, lapho izitshengiselo ezicace khona kodwa umsindo womhlabathi lokungenelwa ngamagetsi kwesuliwe.

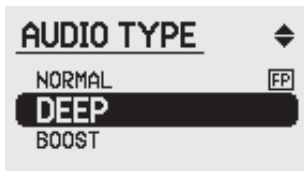

IBoost (GPX 5000)

Le yiAudio Type isebenza ngamandla. IBoost ipha izitshengiselo ezizwaka kuhle kodwa iyengeza njalo lomsindo womhlabathi kumbe ukungenelwa ngamagetsi. Isebenza kuhle emihlabathini emphakathi njalo kude lentambo zamagetsi.

Qaphela: IAudio Type yinye ngayinye ile Rx Gain nxa ungantshintsha iAudio Type.

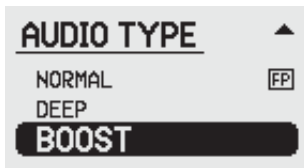

Audio Tone (Umdumo/Umsindo)

Ukuguqula umsindo weThreshold.

GPX 5000 Range	1–100
GPX 4800 Range	1–100
Factory Preset	50



iAudio Tone ungumsinndo weThreshold okhutshwa ngumtshiva.

Amatshe amakhulu ajulileyo aletha umsindo otshiyene lamatshe amancane aseduze. Kuqakathekile ukuthi utshune iAudio Tone ukuze ihambelanela lalokho okudingayo.



iAudio Tone ephezulu ingasiza ekuphaweleni amtshe amancane emsindweni ovela emhlabathini, kodwa iAudio Tone ephansi ingenza ukuthi ukhuthe izitshengiselo ezinkulu.

Ukuzwa kwomuntu munye ngamunye kwelukile njalo ungathola ukuthi uzwa izitshengiselo zamatshe ngcono nxa ufake iAudio Tone ethile. Zama ukusebenzisa ilitshe elikhulu lelincane ube setshuna iAudio Tone uze uyifake lapho ekupha isitshengiselo oleqiniso laso.

GPX 5000 Range

1–20

GPX 4800 Range

1–10

Factory Preset

10 (GPX 5000), 5 (GPX 4800)



Umsebenzi weStabilizer yikuqondisa lapho okulomsindo ozwakala phansi kuThreshold. Lokhu kungaba ngumsindo nje kumbe izitshengiselo zamatshe ezwakalela phansi. Nxa kungavala ilitshe elifunakalayo. IStabilizer yenza uvale umisinjwana engelancedo, ukuthi kube leThreshold ehlalisekileyo, kusenxa wenelise ukubamba izitshengiselo ezizwakalela phansi.

IStabilizer kuhle ihlale ikuFactory Preset uze wazi ukuthi usemhlabathini onjani. Ungavele utshunele iRx Gain emhlabathini okuwo, sokhethile lamanye amasettings omsindo, iStabilizer isingasetshenziswa ukutshuna kuhle ukuthi iThreshold ihlaliseke.

Ukuze uthole indawo eyiyo kanye eyeStabilizer qiniseka ukuthi ikhoyili uyayihambahambisa phezu kwomhlabathi. IThreshold ungayifaka kunombolo eyodwa ngaphansi kwalapho equalisa khona ukungahlaliseki.

Ukwenza kweStabilizer kuyafana lokwenza kwe RX Gain. Kodwa iStabilizer ilokokwenza lokugaywa kwemisingo kuphela njalo kayilani lezitshengiselo ze Receive (Rx), kungako kumele isetshenziswe njengokuutshuna kokucina.

Nxa usuke waguquguquula iStabiliser, nxa umumo womhlabathi ungantshintsha, kumbe ufa ukuntshintsha ikhoyili, kungadingeka ukuthi utshune kutsha iRx Gain. Ungakenzi njalo, buyisela iStabilizer ku Factory Preset. Lokhu kuzakwenza ube leqiniso lokuthi ukhetha uzinga le Rx Gain eliyilo elihambelana lomumo okuwo, ube sutshuna kuhle iStabilizer.

Qaphela: kungenani lokuthi ukhetho yiphi i Audio Type, iStabilizer eqondileyo ngeyinombolo eyodwa ngaphansi kwalapho i Threshold equalisa ukungahlaliseki khona.

Icebo: Ngokutshibikisela inkinobho ye Stabilizer duze kwalapho ecina khona phansi (L3) iThreshold iyahlaliseka, kodwa uazakhutha ubukhali bokubamba amatshe amancane, lokhu kungaba yinto oyifunayo kwezinye indawo, njenga nxa udinga amatshe amakhulu endaweni elengcekeza enengi, kumbe nxa usebenzisa imithshina ye GPX ukudinga amakhoyili lengcebo.

Indlela enhle yokutshuna yile:

- 1 Ketha i Search Mode efaneleyo.
- 2 Khetha i Audio Type oyifunayo.
- 3 Tshuna i RX Gain iThreshold ize iqale ukunqamuka.
- 4 Tshuna i Stabilizer ukuze ulolonge iThreshold.

Signal Peak

Ukuguqula ukukhwela lokwehla komsindo wezitshengiselo samatshe.

GPX 5000 Range	1–20
GPX 4800 Range	1–20
Factory Preset	16



Ulakho ukuzwa isitshengiselo samatshe nxa kuyi kuthi ivolumu lomdumo wesitshengiselo ungatshintshaniswa yikubamba ilitshe kulokuthi uzwe ivolumu yodwa.

Isitshengiselo selitshe emitshineni ye GPX sandise ukuba ngumdumo ekabili. Isitshengiselo esilomdumo oqala wehle ube sukhwela sandise ukuba ngesijulileyo. “Qala ukhwele ubee susehla”, ngowelitshe elincane.

Inkinobho ye Signal Peak itshuna umkhndlo obakhona phakathi komdumo wesitshengiselo ophezulu lophansi.

ISignal Peak etshunelwe phezulu ieyngeza umkandlo womdumo. Kodwa endaweni ezilamatshe lesawudo elinengi umkhandlo ophezulu lo ungenza umtshina ube lomsindo.

ISignal Peak etshunelwe phansi yehlisa umkhandlo womdumo, kungakho izitshengiselo zeliitshe zizazwakala engathi ziyafana.

Qaphela: Abantu abalohlupho lukuzwa endlebeni bangafisa ukusebenzisa iSignal Peak etshunelwe ku 10 kumbe ephansi kwalokhu.

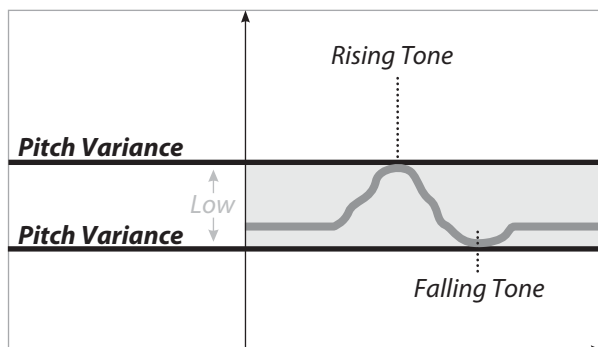
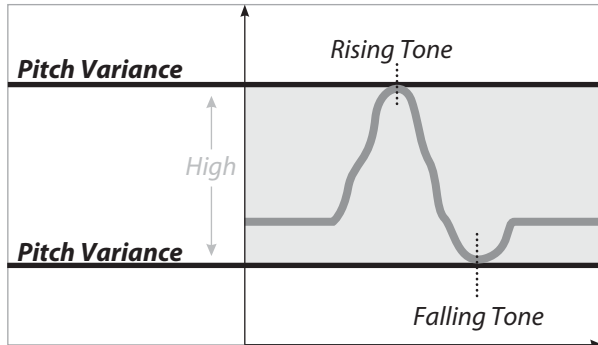

GPX 5000 Range	1–20
GPX 4800 Range	1–20
Factory Preset	8



iTarget Volume

iTarget Volume itshengisa amandla okuthi lokho okudingayo kukhona kumabe hatshi. Njalo nxa ifakwe ngaphezu kuka 8 iyengeza umsindo weThreshold. Lokhu kuyasiza kakhulu nxa kuyikuthi uzingela kulomoya omkhulu, kumbe ebantwini abangezwa kuhle endlebeni kumbe nxa usebenzisa amaspikha amakhulu. Njengoba i-amplifaya ikhona phakathi kwesigxingana sebhathiri leLi-ion, ungxhuma isipikha ebhathirini ube sufaka umsindo wakhona endaweni efaneleyo usebenzisa iTarget Volume.

Uqaphele nxa ususa emasipikheni amancane awendlebeni usisa kwesikhulu, kungadingeka ukuthi untshintshantshintshe iThreshold yakho (p33) lokunqanda ivolumu yakho (p52).

iTarget Volume ingasetshenziswa njengendlela yokukhweza umsindo ezindaweni ezithuleyo kakhulu njalo ingasetshenziswa ukwehlisa kumbe ukulolonga umsindo wenhlabathini elamatshe aligugu amanenginengi. Le yinto eqakatheke kakhulu njalo engasetshenziswa leStabiliser Control, ukuze wenelise ukutshuna kuhle. Kungadingeka ukuthi uqale usebenzise umtshina wakho kwezinye indawo ukuze wazi ukuwutshuna kuhle ungakayi lapho ofuna ukuwusebenzisa khona.

Qaphela: Nxa usebenzisa iTarget Volume ukudinga emhlabathini njalo kudingeka untshintshantshintshe iRx Gain (ngenxa yokuntshintshantshintsha ikhoyili kumbe indawo), bana leqiniso lokuthi iTarget Volume uyibuyisele lapho eyalungiswa ikhona (Factory Preset) kuqala. Usungayitshuna ke ukuthi ihambelane lendawo okuyo.

Icebo: Kuyakhuthazwa ukuthi usebenzise iTarget Volume ephezulu ezindaweni ezilengcekeza enengi, engayisiyo lokho okudingayo.

Ukubonakala kwalokho okudingayo

Ukuguguqula umsindo weTarget (volume).

GPX 5000 Range

GPX 4800 Range

Factory Preset

Normal, Inverted

Factory Set to Normal

Normal

Inkinobho yeResponse iyakuvumela ukuthi wazi ukuthi ilitshe osulibambile likhulu kangakanani.

Kanengi ilitshe elikhulu kumbe amanengi alomsindo oqala wehle uphinde uqanse kuthi ilitshe elincane kumbe amalutshwana abe lomsindo oqala uqanse uphinde wehle. Amatshe amanengi ayandise ukuba mancane, okwenza ujwayele ukuzwa oqala ukhwele uphinde wehle. Nxa udinga amatshe atshonayo njalo emakhulu, ungawuguqula umsindo wakhona ukuze uhambelane lalowo owamatshe amalutshwana.

Normal

Nxa okuthi Normal ube susizwa uthola amatshe amancane, kwandise ukuthi umsindo ukhwele ube susehla. Nxa ungezwa uthola amatshe amakhulu, umsindo wandise ukwehla uphinde ukhwele. Ukuzwa umsindo okutshela ngamatshe owatholayo, kuyangomuntu njalo kuya ngokuthi uzwa njani endlebeni.

Hlanekezeka

Uma ukethe i-Inverted le target encane ikhethiwe, kuba lomsindo owayo uphinde ukwele. iResponse iyangoketho lomntu njalo kusiya ngokuzwa kwakho.

Small Target

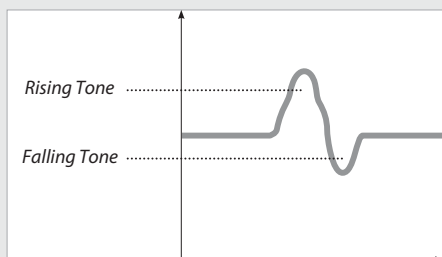

Normal

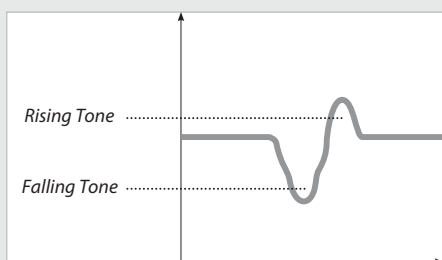

Inverted

Deep Target

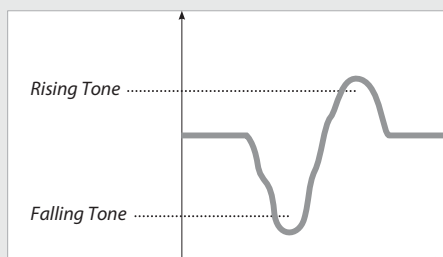

Normal

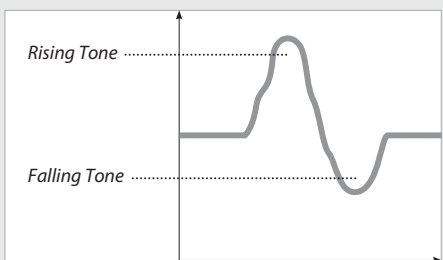

Inverted

Tracking Speed (Isiqubu sokuzingela)

Ukuhambelana lokuntshintsha komhlabathi.

GPX 5000 Range

GPX 4800 Range

Factory Preset

Slow, Medium, Fast

Slow, Medium, Fast

Medium



Kwande ukusetshenziswa iTracking Ground Balance ezindaweni ezilamatshe aligugu amanengi atshiyatshiyeneyo. iTracking Ground Balance ihle izilungise yodwa nxa amatshe emanengi njalo etshiyatshiyene ukuze umtshina ungasanganiseki njalo uphe impumela eziyizo. Isiqubu umtshina ozingela ngaso singaguqulwa ukuze sihambelane lenani lamatshe aligugu atholakala kuleyo ndawo.

Imitshina yohlobo lweGPX 5000 le GPX 4800 ilendlela ezintathu zokuzingela amatshe: Ephangisayo, ephakathi laphakathi lephuzayo.

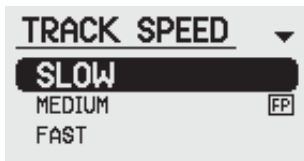

Isiqubu sokuzingela esingcono ngesincane ngoba sihambelana lobunengi bamatshe aligugu emhlabathini. Kumele wengeze iqubu lesi kancane kancane usuka kwesiphansi uze uye kwesiphezulu kakhulu.

Esiphansi (slow)

Isiqubu sokuzingela esiphansi siyakhuthazwa nxa udinga indawo ezilamatshe amakhulu njalo amanengi emhlabathini olenhlobonhlobo zamatshe, kodwa kumele ubone ukuthi kuyahambelana na (p41).

Qapela: Nxa udinga ezindaweni ezilenhlobonhlobo zamatshe aligugu, isiqubu esincane senza umtshina wakho uzulinganise wodwa kuhle ekudingeni kwawo.

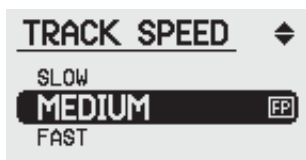

Esphakathi laphakathi (Medium)

Ezindaweni ezisebenzekiyo nxa umtshina ukuFixed, ukuwufaka kuMedium kwenza usebenze kuhle ukuGround Balance njalo umsondo lowana wenze angathi uyama kancane nxa kulelitshe olizwayo.

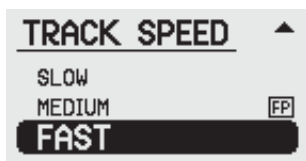

Ephangisayo (Fast)

Isiqubu sokuzingela esikhulu siyasebenza kakhulu ekulinganiseni iGround Balance emhlabathini oyinhlobonhlobo. Isiqubu lesi singasetshenziswa kuphe nxa sidingakala kakhulu.

Ukuzingela lamakhoyili

Ukuzingela kwandise ukwenzakala ngamandla nxa usebenzisa ikhoyili ye Monoloop. Amatshe akhatshana ungawathola. Emhlabathini oyinhlobonhlobo kakhulu kungasebenzeka ngcono kakhulu nxa usebenzisa ikhoyili yeDouble D kule Monoloop, ube usukhetha isiqubu sokuzingela esifaneleyo.

iGround Balance yakuqala egijima kakhulu

Kuzikhathi zonke nxa untshintsha, usuka kuFixed, usiya kuTracking eluhlwini lwamankinobho okuqondisa umtshina, kumbe usebenzisa inkonobho ye Quick-Trak, imitshina yeGPX ihle iziqalisele yodwa iGround Balance egijimayo.

Ukungabambi Insimbi ezile-ayoni

GPX 5000 Range

GPX 4800 Range

Factory Preset

Off (All Metal), 1–10

Off (All Metal), 1–10

Off (All Metal)



Icebo: *i-Iron Reject Off iyenza iPinpointing yetarget iyenzeke kakuhle.*

Qaphela: *Uma usufumane i-target, icoil kumele ihanjiswe phambi langemva phezu kewtarget kanengi. Kumbula uku-seta i Ground Balance ku Fixed, ukuze ungcine ubupatalala lokubaduzane lomhlabathi.*

Imitshina yeGPX iyenelisa ukuthi ingabambi amatshe ale ayoni ngasikhathi sinye ibamba lawo ale ayoni.

Nxa isetshenziswa ezindaweni ezingcole kakhulu, ingcekeza enengi ele ayoni ingatshaywa indiva nje kulamathuba amangi awokuthi amatshe aligugu ingeke iwakhuthe.

Nxa inkinobho ebhalwe Iron Reject icitshiwe, izawabamba wonke amatshe lalawo ale ayoni. Kungakho yonke imihlobo yezinsimbi izabanjwa ngumtshina. Umumo onje waziwa ngokuthi yi'All Metal' njalo yiwo okhuthazwa kakhulu izikhathi ezinengi. Ku All Metal, umtshina uzakupha imisindo etshiyetshiyeneyo isitsho okwehlukeneyo. Lokhu kakuvezi uhlobo lwelitshe elibanjiweyo.

Nxa ilitshelithize selibanjiwe, tshunela kulron Reject efaneleyo, uhambise iGround Balance kuFixed, ube suhambihambisa umtshina phezu kwalapho ozwe khona ilitshelithize. Ikhoyili kumele uyidluladlulise phezu kwelitshe uphindaphinda. Sondeza umtshina phezu kwalapho ozwe khona ilitshelithize, duze lomhlabathi.

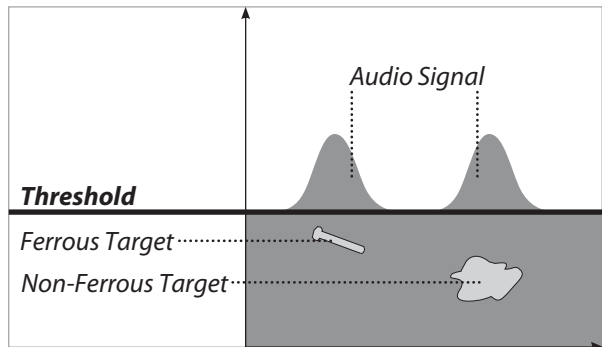

Target signals when detecting in All Metal.



Icebo: ukuze indlela yakho yokwehlukana ibe ngcono, kumele uzame ilitshe lakho uvelela kunhlangothi ezitshiyeneyo ukuze umthsina wakho uthole ithuba 'lokubona' ilitshe lakho ngendlela ezehlukeneyo.



Isixwayiso: Ungaqali ukuzama ukwehlukana ngokuphakamisa langokwehlisa ikhoyili elitsheni elitshone phansi kakhulu kumbe eligejwe lakhanya kancane. Indlela yokwehlukana eqondileyo idinga ukuthi ikhoyili yakho uyihambahambise uyisa emaceleni. Kuyakhuthazwa ukthi ugebhe abanjwe ngumtshina.

Ukwehlukana imihlobo yamatshe ale ayoni langela ayoni kweyame kakhulu kuzitshengiselo eziqinileyo. Nxa isitshengiselo singaqinanga umtshina uzabika ukuthi ubambe ilitshe elingela ayoni, isitshengiselo size siqine, ngenxa yegodi eligebhekayo lokuthi ikhoyili ilokhu isondela elitsheni. Inkinobho yelron Reject yenziwe ngendlela le ukuze ingakhuthi ngitsho, ngasikhathi sinye isehlisa amathuba okukhutha ilitshe elifunekayo.

Kwezinye indawo ezinjengama mayini, izakhiwo ezindala kumbe emapulazini ungakhetha indlela yokwahlukanisa amatshe ephansi. Lokukhu kungenxa yokuthi inhlabathi ezindaweni ezinje kazilamatshe aligugu amanengi, kumbe amatshe akhona yilawo amakhulu angelayo iayoni. Ungasebenzisa indlela ephansi njalo ensimini yegolide elengcekeza enengi engasoze ibanjwe ngumtshina. Inkinobho yelron Reject iyakuvumela ukuthi wengeze indlela yokwahlukanisa usazi ukuthi kungaba lengozi yokuthi ukhutha lalokho okuyikho okufunayo.

Nxa ilron Reject ilayithiwe, umtshina uyala ukubamba amatshe aleayoni ngokuthula zwi nxa kumele kube lesitshengiselo sokuthi kulelitshe. Uzananzelela ukuthi umsindo weThreshold uyazithulela zwi nxa ikhoyili idlula phezu kwelitshe.

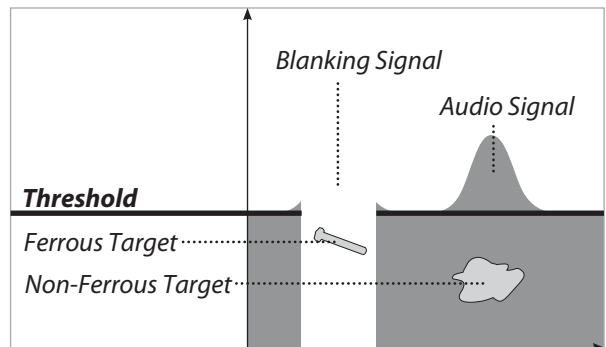

Target signals using Iron Reject. Ferrous target blanked.

Ukungabambi i-ayoni (Iron Reject)

Ukwala ukubamba amatshe ale-ayoni phakathi.

GPX 5000 Range

Off (All Metal), 1–10

GPX 4800 Range

Off (All Metal), 1–10

Factory Preset

Off (All Metal)

Akusiwo wonke amatshe ahle acace ukuthi ale-ayoni kumbe hatshi. Manengi amatshe angachazwa ngokuthi 'angaba' leayoni. Ukuze umtshina wazi ukuthi yiwaphi alawamatshe ale-ayoni, kumele ukhweze Iron Reject. Inombolo ezingaphansi ngezonzalelo olukhulu njalo zizabamba amatshe la angacaciyo ukuthi ami ngaphi njengamatshe angela-ayoni. Nxa Iron Reject ingakhwezwa amatshe angacaciyo amanengi zabanjwa njengamatshe ale-ayoni.



Iron Reject aphansi yenza ukwahlukanisa kungaze kwalahla kakhulu. Amatshe angacaciyo azabanjwa nje njengamatshe angela-ayoni kuthi lawo acacayo ukuthi ale-ayoni enze iThreshold lesitshengiselo kuzithulele zwi. Nxa isitshengiselo sokuthi kulelitshe singelamandla kangako, upha isitshengiselo esikhangelelweyo, uze ugebhe usondele duze kwelitshe ukuze isitshengiselo sokuthi kulelitshe size siqine.



Isibanga selron Reject esiphakathi laphakathi sizakusiza ekuthini ungabambi amatshe ale-ayoni, kodwa ngasikhathi sinye ubamba amatshe alegolide, ikhopha lesiliva.



Isibanga esiphezulu selron Reject sisebenza ngamandla amakhulu, kodwa singcono kakhulu ekuthuleni ukuze umtshina ungabambi i-ayoni. Isibanga lesi singenza ukuthi amanye amatshe amancane afunakalayo (njengegolide elivalwe lilitshle le-ayoni) akhuthwe ngoba esekhanya angathi ilitshle lonke ngele-ayoni kuphela. Isibanga esiphezulu lesi kumele sisetshenziswe kuphela ezindaweni ezilengcekeza enengi, kumbe nxa usebenzisa umtshina wakho ezindaweni ezilamatshe aligugu amalutshwana, udinga amakhoyini lensinjana nje ezincane.



Isixwayiso: Iron Reject kayisebenzi kuhle nxa usebenzisa ikhoyili yeMonoloop.

Iron Reject isebenza kuhle kakhulu nxa ingasetshenziswa lamakhoyili enzelwe yona, athiwa ngamaCommander Double D Coils.

Custom Name (GPX⁵⁰⁰⁰)

Ukutshintsha igama lendlela yokudinga.

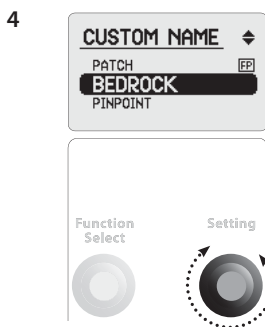
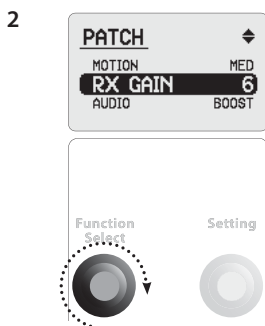

Ungakwenza ukuthi indlela yokuzingela ibizwe ngegama lelo olithandayo wena, phakathi kwezinye ezine, ngegama ongalikhetha eluhlwini lwamagama olukuCustom Name.

Njengomzekeliso, nxa ujwayele ukuzingela emadwaleni, ungetha indlela yakho yokuzingela igama elithi Custom 'Bedrock' Search Mode:

- 1 Khetha uCustom kunkinobho ye Search Mode (etholakala eluhlwini lwamankinobho okuqondisa umtshina).
- 2 Yehla usiya phansi uze ufike kuSearch Mode oyifunayo, njengomzekeliso, Patch.
- 3 Yehla uze uyefika ekucineni kwemanyu uze ubone okubhalwe khona ukuthi Custom Name.
- 4 Usebenzisa inkunobho ye Setting, yehla usiya phansi uze ukhethe u'Bedrock' ube subhodisa inkunobho ye Function ukuze ufake igama osulintshintshile.
- 5 Igama leSearch Mode liyabe selingu 'Bedrock' kuthi leminyeye iminingwane okuyabe kume intshintshwe ukuze ilandele lokhu ihle izenzele yodwa nxa ungawucitsha umtshina wakho.
- 6 Usungasebenzisa ke okufunayo kuboDeep, General loCustom/Bedrock usebenzisa inkunobho yeSearch Mode engaphambili komtshina.

Qaphela: Ungaze utilize konke okunye oyabe ukutshunile ukuthi uqalise kutsha ngeAll Settings Factory Reset, iBedrock leCustom Name yakho kuyagcinwa kungalahlekanga

Custom Names

Patch	Mode 2
Bedrock	Mode 3
Pinpoint	Mode 4
Gridding	Hi-Mineral
Diggings	Lo-Mineral
Salt Lake	Very Deep
Test A	Shallow
Test B	Hi Trash
Mode 1	Beach

Ukukhomba

Ukudinga indawo elelitshe.



Isixwayiso: Ukukhomba ilitshe kumele kwenziwe nge Fixed Ground Balance.

Ukuze uyithole indawo elelitshe, lokuthi unganhle uqale ngokugebha igodi elikhulu kakhulu, kuqakathekile ukuthi ukhomba khona kanye okulelitshe khona.

Nxa ungalizwa ilitshe, qala usuthiseke ngokutshuna umtshina ukuthi ube leGround Balance eqondileyo, lokhu unganwenzeli phezu kwelitshe. Nxa izingela ngeFixed, iGround Balance ungayitshuna ngokufithizela inkinobho ye Quick-Trak, uyale uyifithizele, bese udlulisa ikhoyili phezu kwendawo elelitshe, usiba leqiniso ukuthi umtshina kawulibambi ilitshe lelo (ikhoyili uyihambisele kude lalapho okulelitshe khona). Ungaqeda, sungayiyekela inkinobho.

Nxa ulizwa ilitshe izingela, hambahambisa ikhoyili kancane endaweni elelitshe, ukhatshana lelitshe ngokwalo. Fithizela inkinobho yeQuick-Trak ukuthi iye kuFixed ube sukhomba ilitshe unгани udabula phakathi.

Qaphela: Ukukhomba okuqondileyo kuqakathekile ukuze ungalimazi ilitshe lakho eliyabe lisagqitshelwe, okuyinto engehlisa kakhulu uhlonzi lwalo.



Icebo: Nxa ungenza iGround Balancing endaweni elelitshe, udluladlulise umtshina phezu kwendawo elelitshe, kodwa isitshengiselo sinyamalale, kutsho ukuthi bekungumsindo nje wenhlabathi.

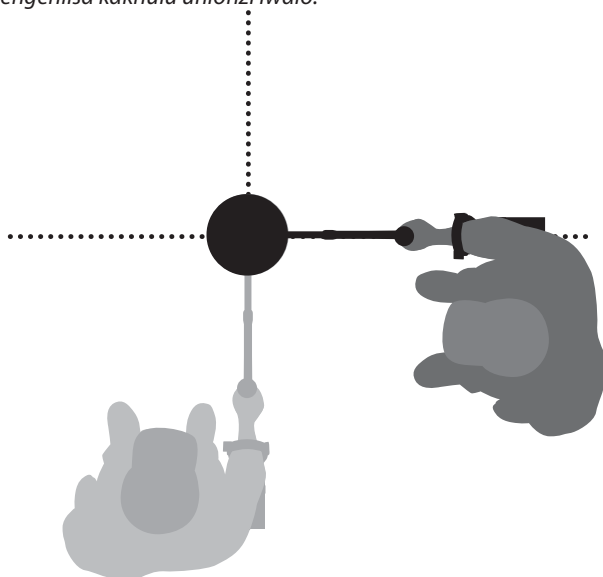

Ukukhomba

Kuyaqhutshwa...



Icebo: Nxa udinga engcekezeni engumhlabathi olula kumbe ichoba, ungadweba imizila usebenzisa iscathulo sakho kumbe ipiki.

Ukuze ukhombe ilitshe elibanjwe ngumtshina, hambahambisa umtshina endaweni yonke njeuqaphela indawo eyiyo ekupha isitshengiselo esiqinileyo.

Ungafinyeza indawo leyo oyiphephethayo ungenelisa ukuthi ucabangele khona kanye okulelitshe khona.

Yenza angathi udweba imizila emibili ehlangana nge 90, uphindaphinda. Ilitshe lilapho okuhlangana khona imizila leyo.

Qaphela: Nxa inkinobho yeCoil/Rx itshunwe yafakwa ku Monoloop kumbe kuCancel, kuyikuthi usebenzisa ikhoyili yeDouble D, ukukhomba akusoze kuqambe ilitshe ngaphakathilaphakathi kwekhoyili, lizabe lisekuyeni esandleni senxele. Imbenge yekhoyili yakwesenxele ingasetshenziswa ukukhomba amatshe angatshonanga kakhulu.

Double D Setting

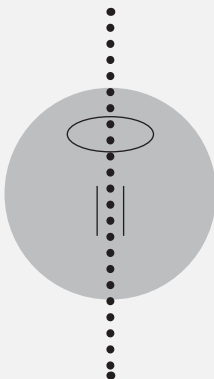

Strongest Signal

Monoloop (Mono) Setting (with Double D coil)

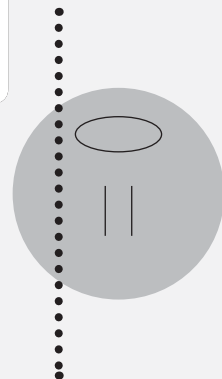
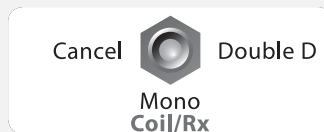

Strongest Signal



Kuqakathekile ukuthi uthwale okunye kwalezi zinto zokugebha nxa uzingela:

– Ipiki elembenge ebanzi (iqakathekile)

– Icrowbar (ukwenzela amatshe atshone kakhulu emhlabathini oqinileyo)

– Ifosholo kumbe ispedi esincane kodwa esiqinileyo (sokusebenzisa ezindaweni ezilomhlabathi olula, etshebetshebeni njalonjalo)

- 1 Susa izinto ezingabe ziphezulu ucinge ukuthi isitshengiselo singabe silokhu sisesekhona yini. Nxa singasekho, ilitshe lingabe selikhutshwe lengcekeza oyikhuphileyo.
- 2 Ukhumbule ukuthi kungaba lezinye izitshengiselo ezingaba eduze lelitshhe lelo. Lokhu kuqakathekile ukuze ungathi usugebha ubuthelele inhlabathi yakho phezu kwamanye amatshe avela elele phezu komhlabathi.
- 3 Nxa istshengiselo silokhu sikhona sebenzisa ipiki ukugebha igodi elitshona okungaba yi 50mm (2").
Qaphela: *Nxa ugebha, ungayenzi imbenge ezicijileyo kakhulu ngoba lokhu kungapha iztshengiselo zamanga, ezingembesa ilitshe. Yenza imiphetho yagodi yehle kuhle ukuze uvikele inhlupho ezingaba khona.*
- 4 Hambahambisa ikhoyili phezu kwegodi ukuze ubone ukuthi ilitshe selikhutshiwe yini. Nxa istshengiselo singasazwakali, kutsho ukuthi ilitshe selisenhlabathini ebuthelelweyo, kungasilokho, gebha utshone ubuye ukhangele njalo.
- 5 Qala ukugebha esibangeni esingaba yi 100mm (4") ngaphambi kwelitshe ukuze wenqabele ukulilimaza. Ukulimaza ikhoyini kumbe yini oyidingayo, kumbe igolide kwehlisa uhlonzi lwakho.

Kuyaqhutshwa ekhasini elilandelayo...

Ukugebha ilitshe

Kuyaqhutshwa...



Njengabana iGPX Series detectors zi-sensitive, ukufumana itarget emhlabathini olula njalo owomileyo kufuna ukubalesineke lolwazi. Iplastic scoop ikuvumela ukudlulisa inhlabathi incane ngaphezu kwecoil ukuthi ikanyise nxa itarget iphakathi. Ukuthwala iplastic scoop kuyanceda ekuphangiseni umsebenzi.

- 6 Nxa isitshengiselo singanyamalala egodini, hambahambisa ikhoyili phezu kwenhlabathi oyigebhileyo ukuze ukhombelapho ilitshe elikhona.
- 7 Thatha inhlabathi engagcwala isandla uyidlulise phezu kwekhoyili.

Qaphela: Ezandleni zakho lengqagala kungabi le watch kumbe into enzwe ngensimbi uma udulisa ingcekeza phezu kwekhoyili.

- 8 Nxa kungelasitshengiselo, beka inhlabathi leyo oyiphethayo ngonanzelelo eceleni, uzame ukuthi ukhombelapho okulelitshe khona njalo, uphinde njalo ngeyinye inhlabathi engagcwala isandla.
- 9 Nxa ilitshe lingaba sesandleni sakho, thela ingxenye yenhalabathi kwesinye isandla. Hlola ingxenye lezo yinye ngayinye ngokudlulisa phezu kwekhoyili.
- 10 Nxa ilitshe lelo lilincane kakhulu ungeke ulibone ngamehlo, thela inhlabathi leyo phezu kwekhoyili ube suqhwayaqhwaya ngomunwe izinto ocabangela ukuthi zingaba lilitshe olidingayo. Isitshengiselo selitshe sizazwakala nxa ilitshe lingafuqwa ngumunwe kancane.

Qaphela: Imitshina ye GPX yimitshina esebenza ngokuhanjiswa. Lokhu kutsho ukuthi ikhoyili ibe ihambahamba phezu kwelitshe kumbe ilitshe kube yilo elihambahambayo phezu kwekhoyili ukuze umtshina ulibone'.



Gqibela igodi lonke oligebhayo

Ngasosonke isikhathi, ugqibele amagodi, uhazahaze amahlamvu lenhlabathi ongabe uyibuthelele ungakahambi. Siza ngokuthi indawo leyo uyitshiye injengokuthi uyithole injani ukuze uphe abasebenzisa imitshina enjengale igama elihle, lokuthi ufihle indawo yakho leyo enothileyo! Ingcekeza yonke ongayithola kumele uhambe layo uyeyilahla ngendlela eqondileyo

Ukugqibela amagodi lokususa ingcekeza kuzasiza ekupheni abasebenzisa umtshina onje igama elihle. Lokhu kuzakhokhelela ekubeni lendawo ezinengi ezilindele ukucubungulwa



Ukuze ungakhuthi ngitsho igolide

Sondeza ikhoyili yakho duze komhlabathi kakhulu.

Ulalesise kahle. Ukulalela kuqakathekile ukwedlula ukudinga ngamehlo.

Hamba kancanekancane, ungajahi, thatha isikhathi sakho.

Uhle uzitshela ukuthi uzathola kuphela, uhle uzibone usiwatholile amatshe lawo owadingayo wena ungakawatholi!

Khumbula ukuthi ukudingisisa ngonanzelelo langobunono obukhulu endaweni encane kungakubhadala kulokudinga uphephuluza phezulu endaweni enkulu.

Landela amacebo lendlela ezilandelayo ukuze zikusize ekusebenziseni amandla emitshina yeGPX, ukuze ube lesiqiniseko sokuthi uphumelele ngaso sonke isikhathi nxa uthe wayazingela.

Ukukhomba izitshengiselo zamatshe

- Amatshe alensimbi ayandise ukupha umdumo 'oqinileyo' njengesitshengiselo nxa ikhoyili ingadluliswa phezu kwawo ivela yiloba kuliphi uhlangothi. Ilitshe elilensimbi landise ukupha istshengiselo esifitshane njalo esizwakala kakhulu. Imisindo nje yenhlabathi yandise ukupha izitshengiselo ezingalolongekanga nxa ikhoyili idluliswa ngenhlangothi ezitshiyeneyo, njalo yandise ukupha isitshengiselo nxa ingahanjiswa ivela ohlangothini olulodwa ibe isizithulela nxa ungaphendukisa umtshina.
- Nxa ungelaqiniso ukuthi umsindo owuzwayo ngowelitshe yini kumbe ngowomhlabathi nje, kumele uxwayisise. Phala okuligodi okungatshoni kangako okungaba yi 30mm (1") phezu kwalapho okungaba lelitshe khona. Dlulisa ikhoyili phezulu kodwa ungayingenisanga egodini. Nxa umsindo wesitshengiselo sewehlile kumbe ungasazewakali kuhle, kungenzeka ukuthi bekungumsindo womhlabathi nje kuphela. Nxa isitshengiselo singayala sinjalo kumbe umsindo waso ukhwele, kutsho ukuthi kebe kulilitshe elilensimbi. Nxa ulokhu ungelaqiniso, tshonisa igodi uphinde konke oke wakwenza.
- Isithunzi selitshe esingabe sigombolozele ilitshe lelo elisagqibelekileyo senza ilitshe lelo likhanye lilikhulu kakhulu emtshineni kulalokhu eliyikho khona. Lokhu kuyehla ilitshe lelo linganyikinywa (njengokuthi ilitshe elincane elibanjwe ngumtshina, kungabanzima ukuthi ulibambe nxa lithe lanyikinywa, selisemhlabathini olula. Nxa lingaphinda ligqitshelwe, isithunzi lesiyana kasiphindi sibe khona.

82 Amacebo okuzingela Ayaqhutshwa...



Amatshe atshone kakhulu

Igolide elinengi kumbe amatshe amakhulu atshonileyo phansi eza isitshengiselo esehlukileyo kulalawo amancane.

Isitshengiselo sakhona sandise ukuba qatha njalo siqinile, lomsindo waso untshintsha nje kancane.

Izitshengiselo zamanga

Nxa uthola izitshengiselo zamanga ekuhambahambiseni ikhoyili, bheka ukuthi lokhu akubangelwa zinsinjana ozithweleyo yini ezinjengepiki, ibhathiri kumbe izicathulo ezilamazwane ensimbi.

Sondeza ikhoyili duze komzimba wakho uphinde uyise kude lawo, ukuze ubone ukuthi izitshengiselo lezi zivela ezintweni lezo na kumbe hatshi. Nxa zivela kuzo, hambisela ikhoyili khatshana lazo.

Ungathwali izinto eziyinsimbi ezikhwameni zakho ngoba ziseduze kakhulu lekhoyili.

- Ungezwa okungumsinjana komhlabathi okuncane, ungakutshayi indiva, kodwa misa umtshina wakho kuhle phezu kwalapho okuzwe khona; kungenzeka ukuthi kuyabe kuyisitshengiselo selitshe elikhulu elitshone phansi kakhulu. Kungcono ukuthi wenze iGround Balance endaweni yonaleyo, ungakadluli phezu kwalo, tshuna umtshina uye kuFixed uzame ukukhomba lapho okule litshe khona.
- Gebha izitshengiselo zamatshe zonke, lanxa kusendaweni eyake yazingelwa. Imitshina yeGPX isebenza ngohlonzi lwaphezulu, kungakho kuyenzeka ukuthi uthole amatsha ezindaweni esezake zagejwa ngabanye kudala, lapho eminye imitshina eyehluleka khona ukumelana lobunengi benhlobonhlobo zamatshe kumbe isawudo.
- Kwezinye indawo lapho okulenhlobonhlobo zamatshe ungathola izitshengiselo emhlabathini obomvu kumbe esidakeni. Khumbula ukuthi umsindo welitshe elilensimbi uyakhula nxa ungasondeza ikhoyili eduze lelitshe.
- Nxa uzingela emhlabathini olenhlobonhlobo zamatshe ezinengikakhulu zingela ulandela imifolo lamakantiwa kulokuwaquma phakathi. Lokhu kwenza umsebenzi womtshina uhlaliseke.
- Ezindaweni ezinohlelo ngamatshe aligugu, kungadingeka ukuthi uhambahambise umtshina utshiye umhlabathi ngesibanga esingaba yi 10-20mm (1/2-1"). Lokhu kuzakunika iThreshold ehlalisekileyo kwenze lomsindo womhlabathi ube mlutshwana.
- Nxa inani lamatshe aligugu emhlabathini lingamane lintshintshe nje kumbe liguquke kakhulu kungaba lesitshengiselo emtshineni. Isitshengiselo lesi sandise ukuba sikhulu njalo sikhomba ngakuhlangothi olulodwa

Imitshina yeGPX ibuya ilekhoyili yeDouble D11". Ikhoyili le ihlanganisa izinto ezithi ukujula, ubukhali lokuhlaliseka. Isebenza kuhle njalo lelron Reject.

Phezu kwalokhu, akhona amanye amakhoyili amanengi angaphathisa ekuthini umtshina wakho usebenze kuhle kakhulu. Abalela phakathi amakhoyili amancane abukhali ekubambeni amatshe amatshe amancane, ayathwaleka njalo ayasebenziseka ezindaweni ezenileyo kakhulu, kumbe lamakhoyili amakhulu ajulileyo njalo asebenza ngcono emhlabathini.



10" x 5" Elliptical Double D

Leyikhoyili umzingeli wonke afuze ayithwale ngoba yenzaizinto ezinengi. Isebenza kuhle kakhulu ezindaweni ezenileyo, ezilenhlobonhlobo zamatshe lezilengcekeza enengi. Ilobukhali lokujula ongeke wakucabangela ukuthi kukhona ekhoyilini encane kangaka. Isena kuhle njalo ekukhombeni amatshe atshone kakhulu angabanjwa kuphela ngamakhoyili amakhulu njalo ihlalisekile kakhulu emihlabathini eminengi.



15" x 12" Semi-Elliptical Double D

Ikhoyili le ilokujula okukhulu njalo isebenza indawo enkulu kule 11" DD njalo isebenza ihlalisekile emihlabathini yonke. Le yikhoyili enhle okwamagama engasebenza loba ngaphi ezindaweni ezilamathse amanengi aligugu, ilula njalo ingantsentsheka ibe yi 18"DD nxa udinga amatshe amakhulu endaweni ezilamathse ayinhlobonhlobo. Ukwenziwa kwayo kwenza ibe lobukhali obukhulu obungahambelani lobukhulu bayo.

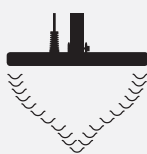

Monoloop

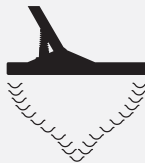

Monoloop
(Side view)

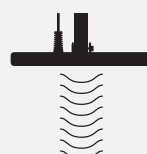

Double-D

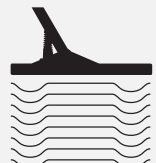

Double-D
(Side view)

Amakhoyili ohlobo lweCommander

Ayaqhutshwa...



18" Round Double D

Le yikhoyili ezimisele umsebenzi eyenzelwa umuntu ozimisele umsebenzi. I 18" Double D ifuqa ingene phakathi kwamatshe amanegi, ngapha isebenza kuhle ilolongekile ukuze uzwe izitshengiselo, ezitshonileyo ezingaba khona.



8" Round Monoloop

Yiyo ebukhali kakhulu kulawo wonke amakhoyili ohlobo lweCommander. Isigombolozo esiyi 8" siletha ukujula okuhle kakhulu ematsheni amancane kakhulu emihlabathini elamatshe amalutshwana kusiya kwelamatshe amanengi. Yikhoyili ethanda ukusetshenziswa lapho okwake kwagejwa khona, njalo isebenza kuhle endaweni ezenileyo kakhulu, njalo isebenza kuhle ekubambeni izinto ezenziwe ngegolidelakhoyini amancane akhandwayo.



11" Round Monoloop

Le yikhoyili elula ebukhali njalo eyenila ukubamba amatshe ajule kakhulu nxa kuqathaniswa le Double D. I11" Monoloop, yikhoyili enhle engasenza iloba kuwuphi umumo. IyiCommander Monoloop esesigabeni sesibili ngobukhali, njalo ngeyinye yamaMonoloop ahlalisekileyo kakhulu angatholakala njalo iyala ihlalisekile emihlabathini emineni etshiyatshiyaneyo.

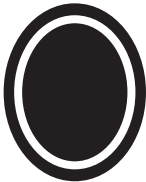

15" x 12" Semi-Elliptical Monoloop

Ematsheni amakhulu, ikhoyili le ilokujula okungcono kule 11" Monoloop le 15"x12" Double D. Ibukhali kabi. Isebenza kuhle ekuzingeleni ezindaweni ezingenanga kakhulu lekudingeni amatshe atshone kakhulu ezindaweni ezilenkotha lezihlahla ezinengi ukuze i18" Monoloopisebenze kuhle. Yikhoyili ehlaiseke kakhulu njalo esebenza kuhle emihlabathini yonke ngaphandle kwemibi kakhulu. Ikhoyili le ingumathadwa wabantu abanengi.



18" Round Monoloop

Ilokujula okuhle kakhulu njalo ibukhali emihlabathini elamatshe amalutshwana kusiya kuleyo elamatshe aphakathi laphakathi. Ikhoyili le iyawabamba amatshe ezindaweni esezisetshenzwe kakhulu, lapho abanye asebekhalale khona.

Kulezinto ezinhlano ezimqoka okumele uzinanzele nxa usacanga ukuthi uthathe yiphi ikhoyili:

Ubukhulu bekhoyili

Ikhoyili enkulu ingabamba amatshe amakhulu atshonileyo phansi kodwa ingakhutha kumbe yehluleke ukubamba amancane. Ikhoyili encane ibukhali ekubambeni amatshe amancane kodwa kayitshoni njengenkulu.

Ubunengi bamatshe aligugu

Ikhoyili yeMonoloop isebenza ngcono kuleDouble D kodwa ibuya ibe nzima ukuthi uyifake kuGround Balance kungakho ingaba lomsindo. Ikhoyili yeDouble Balance ihlalisekile ezindaweni ezilamatshe aligugu amanengi.

Isimo somhlabathi lezimila

Ikhoyili encane ilula ukuyihambihambisa phakathi kwezixuku ezenileyo lasemhlabathini omagodigodi. Ikhoyili encane ilula ukuyithwala njalo kulenkulu.

Ukwehlukana amatshe

Ezindaweni lapho okudingeka ukuthi kube lokwehlukana, iDouble D iyafunakala ukuze ilron Reject isebenze. Ezindaweni ezilengcekeza enengi kakhulu ikhoyili encane ingasebenza ngcono.







Indlela yokudinga

Ikhoyili yeDouble D ilendlela yokudinga enjengembenge esuka ezwaneni uze uyefika esithendeni sekhoyili, okuhle kuvale umhlabathi wendawo enkulu. Ikhoyili yeMonoloop ilendawo yokubamba engathi yisihlothi esicijileyo okwenza kudingeke ukuthi uhambahambise ikhoyili yakho ngokuphindiweyo ukuze ungakhuthi lutho.

Qaphela: Amakhoyili lamalunga omtshina kuyatholakala kukodwa. Lawa kawalungiswa njalo kawasekelwa yiMinelab. Unanzele ukuthi amakhoyili la ozithengela wedwa ezitolo nxa ungawasebenzisa emitshineni yeGPX, ube sutshunela kuSoil/Timings athi 'Fine Gold' kumbe 'Enhanced' angangasebenzi kumbe angaphi izitshengiselo eziqinileyo emhlabathini olawo amatshe aligugu.

Ukukhetha ikhoyili eqondileyo

Kuqhutshwa...

	Small, Shallow Nugget	Large, Deep Nugget	Highly Mineralised	Less Mineralised	Open Ground	Heavy Scrub	Iron Disc.
10" x 5" Elliptical Double D 							
15" x 12" Semi-Elliptical Double D 							
18" Round Double D 							
8" Round Monoloop 							
11" Round Monoloop 							
15" x 12" Semi-Elliptical Monoloop 							
18" Round Monoloop 							

 – Amabhokisi aconjiweyo atshengisa ukuthi ikhoyili ethize isetshenziswa ngaphi.

 – ingasebenza kuhle ku 'Enhance, Fine Gold laku Sensitive Smooth'.

<p><i>Akuzwakali msindo</i></p>	<ul style="list-style-type: none"> - Bheka ukuthi umtshina ulayithile yini (ibhathiri, intambo, ukukhumana, iglazi) - Tshibilikisela inkinobho yeThreshold esandleni sokudla - Khweza ivolumu iye ekucineni ku 20 - Bheka ukuthi amaspikha amncane endlebeni axhunyiwe yini - Bheka inkinobho yevolumu yezipikha zendlebeni - Zama ukusebenzisa ezinye izipikha kumbe elinye ibhathiri
<p><i>KukuThreshold kodwa akulasitshengiselo</i></p>	<ul style="list-style-type: none"> - Zama ukusebenzisa amakhoyili atshiyeneyo phezu kwelitshe okwaziyo ukuthi likhona
<p><i>Kulomsindo ongaqondakaliyo</i></p>	<ul style="list-style-type: none"> - Yenza iGround Balance njalo - Tshuna kutsha usebenzisa inkinobho ye Auto Tune - Faka inkinobho ye Coil/Rx kuCancel - Yehlisa iGain - Suka eduze kweminye imitshina esebenza khonapho - Suka nxa kusiza izulu eliphazimayo
<p><i>Ibattery kalitshaji</i></p>	<ul style="list-style-type: none"> - Bheka ukuthi ukhona yini unlilo usebenzisa itshaja yasemoteni - Bheka I fuse kuplagi ye 12 - Bheka izindlela ze LED zebhathiri (p20).
<p><i>Ibattery kalibambi itshaji</i></p>	<ul style="list-style-type: none"> - Xhumela itshaja kweyinye indawo - Bheka intambo ehambisa umlilo - Tshintsha ibhathiri
<p><i>Kuphuma umbiko othi 'Coil Overcurrent'</i></p>	<ul style="list-style-type: none"> - Citsha umtshina, ume okwemizuzana emilutshwana ungakaphindi uwulayithe.

Ibhokisi lokuqondisa umtshina (Control Box)

Kulapho okuvalelwe khona indlela okuhamba ngazo umlilo emtshineni. Ibhokisi leli ligaya izitshengiselo ze Tx ezilethwa yikhoyili lihlaziye izitshengiselo zeRx ezibanjwe yikhoyili. Inkinobho zonke zingaphambili langemuva kwebhokisi leli.

Ukwehlukana

Lokhu yikwenelisa komtshina ukwehlukana ukuthi into ewubambileyo ngele-ayoni (ferrous) na kumbe hatshi (non-ferrous).

Amakhoyili ohlobo lwe Double D

Izigaga zamawaya ezimbili ziyagadaniswa engathi ngo 'D' ababili (abafulatheleneyo).

IElectromagnetic Field

Yandise ukubizwa ngokuthi 'yisitshengiselo esisuka kukhoyili'. Ielectromagnetic field idaleka phakathi kwezigaqa zamawaya ekhoyili ibe sithunyelwa phezu komhlabathi. nxa kungaba lensimbi emhlabathini, umoya lo uyaphambaniseka. Ukuphambaniseka komoya lokhu kube sekuzwiwa zindlebe zomtshina, kuthi lowo owusebenzisayo ezwe okungumsinjwana nje.

Izitshengiselo zamanga (False Signals)

Lezi zizwakala zifana leziyizo ezamatshe kodwa zibangelwa ngezinye izinto ezisemaceleni. Okwande ukubangela izitshengiselo zamanga lezi yiGround Balance engaqondanga, amadwala atshisayo, izitshengiselo ezibangelwa yikutsheyelela ikhoyili wmadwaleni, njalo njalo. Ngokujwayela, umsebenzisi womtshina uzafunda izindlela zokwehlisa izitshengiselo lezi lokuthi azwe umahluko phakathi kwesitshengiselo seqiniso lesamanga.

Insimbi ezile-ayoni (ferrous metals)

Lezi zinsimbi ezibunjwe kumbe ezile-ayoni. Insimbi enje ingabanjwa ngumaginethi njalo yenziwe nge-ayoni kumbe istili.

IGround Balance

Lokhu yikwenelisa komtshina ukumelana lenhlupho ezilethwa ngomhlabathi olenhlobonhlobo zamatshe. Imitshina yeGPX ileGround Balance ezisebenzela yodwa nje. Nxa iGround Balance isetshenziswa iTracking iyaqhubeka ilungisisa nxa kuthe kwaba lenguquko ethize kunhlobonhlobo zamatshe ezisemhlabathini.

Halo Effect

Nxa into eyinsimbi isihlale okwesikhathi eside emhlabathini inganyikinywanga, kusuka kube lokuqhela okuthize ingani ingena emhlabathini lowo oyigombolozelayo. Lokku kwenza into leyo ikhanye emtshineni engani inkulu kulalokho eyikho khona.

Idwala elitshisayo (hot rock)

Leli lidwala elilodwa elilamatshe aligugu amanengi nxa kuqathaniswa lomhlabathi oligombolezeleyo. Ngenxa yomahluko lo, umtshina kawutholi thuba lokwenza iGround Balance edwaleni lelo elitshisayo, kube sekusiba lesitshengiselo samanga. Isitshengiselo leso siphela ngokuphangisa nxa ungengeza umkhandlo otshiywa yikhoyili phezu kwedwala lelo.

Interference

Amagetsi kumbe amagagasi omsakazo asendaweni angabangela ukungahlaliseki kumbe ukuhayiza kweThreshold. Ukungenela lokhu kwande ngenxa yentambo zamagetsi, intambo zangaphansi komhlabathi, irada, eminye imitshina kumbe umumo womkhathi njengezulu eliduma kakhulu.

Ukwanda kwamatshe aligugu isawudo kanye lemithi ethize emhlabathini (mineralization)

Imihlabathi eminengi ilamatshe angabangela ukuthi kube lezitshengiselo zamanga. Umhlabathi olamatshe aligugu amanengi kakhulu udinga indlela yokuzingela ehlukeyo kuleyo esetshenziswa emhlabathini ondikindiki kumbe olamatshe amalutshwana. Umhlabathi olesawudo elinengi lawo ufuna ukusetshenzwa ngendlela ehlukeyo.

Amakhoyili eMonolooop

La ngamakhoyili enziwa ngokuthatha amawaya amanengi enziwe igoda abesethandela isigombolozisi sekhoyili. Lapho okudinga lakhona iMonolooop kucijile. Amakhoyili la apha ukujula okukhulu lobukhali nxa eqathaniswa le Double D elingana layo, ezindaweni ezilamatshe amalutshwana kusiya kwaphakathi laphakathi.

Insimbi ezingela-ayoni (non-ferrous metals)

Lezi zinsimbi ezingela ayoni enengi. Ngezingabanjwa ngumagethi njengegolide, ikhophla, isiliva, ibhrasi, ilidi le aliminyamu.

Ukukhomba

Yindlela yokugqamba khonakanye okulelitshe khona ungakagebhi. Ukukhomba kusebenzisa indlela ikhoyili eyenziwe ngayo ukuze ubone khona kanye lapho okulelitshe elibanjweyo khona.

Rx (Receive)

Kutsho isitshengiselo esilethwa yi magnetic field kukhoyili esisetshenziswa libhokisi lokuqondisa umtshina ukubamba ilitshe elisemhlabathini.

90 | Amagama lengcazelo zawo Kuyaqhutshwa...

Amatshe alisawudo

Nxa kulesawudo emhlabathini, umtshina upha isitshengiselo esithi hatshi (-) kulesithi yebo (+).

Isawudo elinengi emhlabathini lipha isitshengiselo esihlukileyo kwamanye amatshe. Kungakho umtshina kumele usebenzise indlela zokusefa ezehlukileyo ukuze unqobe loluhlupho.

Search Coil (ikhoyili yokudinga)

Ikhoyili yokudinga yinsimbi eyisigombolozisi eyiyo ehanjani phezu komhlabathi nxa uzingela. Ihambisa i-electromagnetic emhlabathini ibe isisamukela izitshengiselo ezivela khona.

Search Pattern (indlela Yokudinga)

Le yindawo esemhlabathini ongaphansi kwekhoyili, lapho okudingwa khona. Kusiya ngokuthi usebenzisa ikhoyili enjani (Double D kumbe iMonoloop) langokuthi inkinobho ye Coil/Rx itshunwe njani (Double D/Monoloop/Cancel) amakhoyili atsheyeneyo apha sismilo esitshiyeneyo esihambelana lokubunjwa kwawo umhlabathi asebenza kuwo.

IThreshold

Umsindo ongacitshiyi okhutshwa ngumtshina uthiwa yiThreshold. IThreshold ingafakwa loba ngaphi phakathi kua sile lo loud; kodwa umsinjwana omncane obuthakathaka yiwo okhuthazwayo.

Target Signal

(isitshengiselo selitshe) lokhu yinguquko eba khona emsindweni lakuvolumu ye threshold nxa umtshina usuthe wabamba ilitshe ongalilahlanga.

Tracking (ukuzingela)

Yinkinobho ye Ground Blance ezintshintsha yodwa nxa umtshina lawo ungazintshintsha wodwa ukuze iGround Balance ihambelane lomumo womkhathi.

Tx (Transmit)

Lokhu kutsho izitshengiselo ezihanjiswa ngumtshina kumbe umoya ohanjiswa yielectromagnetic emhlabathini yikhoyili.

Ukunakekela umtshina wakho

(Ukunakekela ibhathiri lakho, ikhasi 21)

Imitshina ye GPX yizitsha zamagetsi zohlolzi lwaphezulu. Nakekela umtshina wakho ngendlela elandelayo:

Ibhokisi lokuqondisa umtshina lingamelana lobumanzi kodwa amanzi ayangena phakathi kwalo. Gcina indawo zonke lapho okuxhunywa khona ezihambisa umlilo ziwomile.

Ikhoyili ingasetshenziswa nxa kulomfefezo kodwa ungayigxamuzi emanzini.

Ibhokisi lokuqondisa umtshina akumelana lithintane ngitsho lephethro kumbe amanye nje amfutha.

Hlala uthintitha ingcekeza kumbe uthuli ebhokisini lokuqondisa umtshina usebenzisa isibhrasho sokupenda esiwomileyo. Hlikihla umgqala womtshina ngelembu elilunama usebenzisa isepa encane kakhulu. Ungasebenzisi imithi yokususa ingcekeza elenkani. Insimbi evikela ikhoyili iphetha idleke yaphela ngenxa yokuphala ngayo umhlabathi nxa uzingelaukusebenzisa isivalo sekhoyili ongasintshintsha ufake esinye kungasiza ekugcineni ikhoyili yakho. Hlala ufaka izinto ezivikela ikhoyili ezintsha ezinjengamawasha lamaplethi ukuze umtshina wakho uphile isikhathi eside.

Ukuze wenqabele ukuthi ngcekeza ingene phakathi kwekhoyili ungasebenzisa isilk tape (leukosilk). Isilk tape iyatholakala ezitolo ezithengisa amaphilisi lemithi. Ukusebenzisa ama carbon based tapes anjenge insulation tape kungehlisa ubukhali bomtshina wakho.

Ukuze wenqabele ukuthi ngcekeza ingene phakathi kwekhoyili ungasebenzisa isilk tape (leukosilk). Isilk tape iyatholakala ezitolo ezithengisa amaphilisi lemithi. Ukusebenzisa ama carbon based tapes anjenge insulation tape kungehlisa ubukhali bomtshina wakho.

Ungavuli ibhokisi lokuqondisa umtshina ngoba lokhu kwenza iwaranti yakho ingasebenzi. Nxa kukhona okufuna ukulungiswa phakathi kwebhokisi lokuqondisa umtshina, ibhathiri lekhoyili buyisela eMinelab kumbe ebantwini abphiwe imvumo ngabeMinelab ukuthi bakulungisele.

Ungavuli ibhokisi lecontrol kwenza iarranty yakho ingabi isasebenza. Ukulungiswa kwebhokisi lecontrol, lebattery necoil, kumele kuthunyelwe kwabeMinelab noma ummeli ovunyelwe ngabeMinelab.



Ukuhamba lomtshina wakho

Nxa uzahamba ngefulayimatshina yazi ukuthi amanye amakhampani kawavumi ukuthwala amabhathiri e Li-ion.

Izeluleko ezimayelana lokuhamba lomtshina zitholakala ku:
www.MINELAB.com

GPX 4800 Main Menu (Universal Functions)

Function	Range	My Preferred
Backlight	Off, 1–8	
Battery Test	0–8.0V, +8.0V	
Volume Limit	1–20	
GB Type	General, Off	
Special (Soil/Timings)	Sens Extra, Sharp, Coin/Relic, Salt-Coarse	
Manual Tune	0–255	

GPX 4800 Search Mode Menu (Mode Specific Functions)

Function	Range	General	Deep	Hi-Mineral
Motion	Very Slow, Slow, Medium			
Rx Gain	1–15			
Audio Type	Quiet, Normal, Deep			
Audio Tone	1–100			
Stabilizer	1–10			
Signal Peak	1–20			
Target Volume	1–20			
Tracking Speed	Slow, Medium, Fast			
Iron Reject	Off, 1–10			

GPX 5000 Main Menu (Universal Functions)

<i>Function</i>	<i>Range</i>	<i>My Preferred</i>
Backlight	Off, 1–8	
Battery Test	0–8.0V, +8.0V	
Volume Limit	1–20	
GB Type	General, Specific, Off	
Special (Soil/Timings)	Sens Smooth, Fine Gold, Sens Extra, Salt/Gold, Sharp, Coin/Relic	
Manual Tune	0–255	

GPX 5000 Search Mode Menu (Mode Specific Functions)

<i>Function</i>	<i>Range</i>	<i>General</i>	<i>Deep</i>	<i>Patch</i>	<i>Hi-Mineral</i>	<i>Hi-Trash</i>	<i>Pinpoint</i>
Motion	Very Slow, Slow, Medium, Fast						
Rx Gain	1–20						
Audio Type	Quiet, Normal, Deep, Boost						
Audio Tone	1–100						
Stabilizer	1–20						
Signal Peak	1–20						
Target Volume	1–20						
Response	Normal, Inverted						
Tracking Speed	Slow, Medium, Fast						
Iron Reject	Off, 1–10						

Detector

<i>Transmission</i>	Pulse Induction
<i>Technology</i>	Multi Period Sensing (MPS), Dual Voltage Technology (DVT), and Smart Electronic Timing Alignment (SETA)
<i>Coil</i>	11" Round
<i>Audio Output</i>	6.35mm (¼") headphone/speaker socket Headphones supplied
<i>Liquid Crystal Display (LCD)</i>	64 x 128 pixels, transfective with white backlight
<i>Length</i>	Extended: 1300mm (51.2") Collapsed: 1100mm (43.3")
<i>Weight, including 11" Coil (Excluding Battery and Accessories)</i>	2.4kg (5.3lbs)
<i>Operating Temperature Range</i>	0°C to 45°C (32°F to 113°F)
<i>Storage Temperature Range</i>	-20°C to 65°C (-4°F to 149°F)

Battery

<i>Type</i>	Lithium-ion
<i>Output Voltage</i>	7.4V, up to 8.4V when fully charged Maximum discharge current is 1A
<i>Capacity</i>	9.2Ah
<i>Input (Charge)</i>	12-24V DC / 2-3A
<i>Weight</i>	780g (1.72lbs)
<i>Operating Temperature Range</i>	0°C to 45°C (32°F to 113°F)
<i>Storage Temperature Range</i>	5°C to 25°C preferred, -5°C to 65°C maximum (41°F to 77°F preferred, 23°F to 149°F maximum)
<i>Battery Charge Temperature Range</i>	0°C to 45°C (32°F to 113°F)

Ibhokisi lokuqondisa imitshina ye GPX 5000 le GPX 4800 lilewarranti egoqela amalunga alo lokulungiswa kwakhona. Amakhoyli ohlobo lweCommander ale waranti nxa engasebenzi kuhle.

Ibathiri lalo lilewarranti nxa lingasasebenzi.

Iwaranti iqala mhla uwuthenga umtshina.

Khangela ekhadini le Product Warranty ukuze uthole imininingwane yonke ephathelane lesikhathi sewaranti.

Iwaranti yeMinelab kayisebenzi nxa kuyikuthi umtshina ufe ngenxa yesinye salesizizatho: ingozi, ukungasetshenziswa kuhle, ukungananzwa, ukuntshintshantshintshwa kumbe ukuwulungiswa ebantwini abangavunyelwayo.

Iwaranti ungeke uyisebenzise komunye umtshina. Ikhadi lokubhalisa iwaranti olithola phakathi komtshina kumele libuyiselwe ekhampanini ye Minelab Electronics Pty Ltd kumbe esitolo sabo esiseduzane lawe kungakadluli amaviki amabili uwuthengile umtshina.

Nxa ufuna ukubuyisela umtshina wakho eMinelab ukuze uyelungiswa, gcwalisa iphepha le Minelab Service Report Form. Sicela ufake igama lakho, ikheli lenombolo zocingo lelanga owawuthenga ngalo lenombolo yomtshina (serial Number), nxa uthumela amalunga omtshina ukuthi ayelungiswa. Uchaze kabanzi ukuthi uhlupho lungaphi ukuze omanjinela bethu balungise umtshina wakho ngokuphangisa njalo kuhle. Phendukisa ifomu lomtshina kusebhokisini ukuze kugcineke kuhle.

Ungavuli ibhokisi lokuqondisa umtshina wakho ngoba lokhu kwenza iwaranti yawo ingasebenzi.

Qaphela: kungumlandu wakho njengomnikazi womtshina ukuthi ubhadale indleko zokuthwalwa komtshina wakho nxa usiyalungiswa eMinelab.

Nxa umtshina wakho ulokhu ungaphansi kwe waranti, umtshina wakho uzaphenduka ungawubhadalela indleko zokuphenduka.

Service and Repair Form

Today's Date

Detector / Model

Serial Number

Purchased From

Purchase Date

Part(s) Sent

Owner's Name

Address

Telephone () Day

Home

Mobile

Fax ()

Email

Description of Fault

Please explain how we can replicate the problem in order to repair your detector.

cut out or photocopy



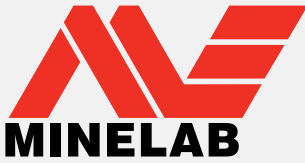

World's Best Metal Detection Technologies

From our origins in 1985, Minelab have specialised in advanced electronic technologies. Our competitive advantage was created almost immediately with a highly competent and innovative Research and Development team, inspired by the genius of Mr Bruce Candy.

This commitment to innovation has enabled us to successfully market feature packed Consumer coin and treasure detectors enjoyed by hobbyists worldwide as well as high quality gold detectors used by both professionals and amateurs. Minelab's advanced technology is also incorporated in detection equipment designed for military and humanitarian de-mining projects throughout the world.

Today Minelab has manufacturing, distribution and customer service operations in Australia, Europe and the United States, and is an ISO 9001 Quality Endorsed Company. ISO 9001 is a worldwide quality standard certification that ensures the highest level of product quality for our customers.

© 2009 Minelab Electronics Pty Ltd

This document contains proprietary information which is protected by copyright. Apart from any use as permitted under the Copyright Act 1968, no part may be reproduced by any process without written permission from Minelab Electronics Pty Ltd, 118 Hayward Avenue, Torrensville, SA 5031, Australia.

WARNING. This document contains Minelab Electronics Pty Ltd rights, technical data or restricted rights data, or both. Patents and trademarks apply.



Working for a Cleaner, Greener Future

For Consumers within the European Union: Do not dispose of this equipment in general household waste.

The crossed wheeled bin symbol on this equipment indicates this unit should not be disposed of in general household waste, but recycled in compliance with local government regulations and environmental requirements.

Please dispose of this equipment via a recycling service or centre, or by returning the unit to the respective Minelab outlet as appropriate for your unit. This will enable the equipment to be disposed of in an environmentally safe manner.

Disposal of unwanted electronic equipment in land filled waste may contribute to adverse long term environmental effect due to the leaching of contaminating and toxic substances contained within some electronic equipment.

THIS DEVICE COMPLIES WITH PART 15 OF THE FCC RULES

Operation is subject to the following two conditions: (1) this device may not cause harmful interference, and (2) this device must accept any interference received, including interference that may cause undesired operation.

Disclaimer:

The Minelab metal detector discussed in this operating manual has been expressly designed and manufactured as a quality hobbyist metal detector and is recommended for use in coin, treasure and general metal detection in nonhazardous environments. This metal detector has not been designed for use as a mine detector or as a live munitions detection tool.

Please note:

Since there may be a variety of options available for this detector, equipment may vary according to the Model or items ordered with your detector. Certain descriptions and illustrations may also differ (in this manual) from the exact Model that you purchased. In addition, Minelab reserves the right to respond to ongoing technical progress by introducing changes in design, equipment and technical features at any time.



Minelab Electronics Pty Ltd

PO Box 537, Torrensville Plaza
Adelaide, South Australia, 5031

Australia

Tel: +61 (0) 8 8238 0888

Fax: +61 (0) 8 8238 0890

Email: minelab@minelab.com.au



Minelab International Ltd

Unit 207, Harbour Point Business Park,
Little Island, Co. Cork,

Ireland

Tel: +353 (0)21 423 2352

Fax: +353 (0)21 423 2353

Email: minelab@minelab.ie



Minelab Americas Inc

2777 Finley Road, Unit #4,
Downers Grove, IL 60515,

USA

Tel: +1 630-401-8150

Fax: +1 630 401 8180

Email: info@minelabamericas.com